

Rules of casino games in Great Britain
August 2007

Contents

1.	Introduction	3
2.	General Rules	7
3.	Roulette	9
4.	Blackjack	15
5.	Three Card Poker	24
6.	Punto Banco	28
7.	Casino Stud Poker	35
8.	Dice/Craps	40
9.	Sic Bo	46
10.	Big Six (Wheel of Fortune)	50
11.	Texas Hold 'Em Poker	53
12.	Let it Ride	68
13.	Pai Gow Poker	75

1 Introduction

- 1.1 The Gambling Act 2005 (the Act) gives the Gambling Commission (the Commission), as part of its statutory role, the power to attach to any casino operating licence conditions which specify the types of casino game that can be made available. The Commission may also specify rules for casino games or any equal chance game played in a casino.
- 1.2 In June, the Commission published the document, *Licence Conditions and Codes of Practice* (LCCP June 2007). That document contains the conditions and codes that will apply to each of the sectors the Commission will regulate under the Act.
- 1.3 LCCP (June 2007) explains that non-remote casino operating licensees must only offer or permit to be played certain games that appear on the list of approved casino games. There is one exception to this; games may be made available for a specified period in accordance with a Commission approved trial of a proposed new game. LCCP (June 2007) also set out that licensees must follow any rules for the playing of approved casino games, or other games of chance, as may be prescribed by the Commission.
- 1.4 The Commission stated that those casino games permitted in casinos prior to 1 September 2007 will automatically be included on the list of approved games under the Act, which will come into force on 1 September 2007. Following discussion with the industry it has been decided that Baccarat (banque), Chemin de Fer, and Super Pan 9 should not be included on the approved list as these are no longer played in British casinos.

Background

- 1.5 In September 2006 the Commission consulted on the types and rules of casino games. The Commission's approach was to:
 - make use of existing standards and arrangements that remain useful and applicable under the new legislation;
 - discard elements which do not fit in with the Commission's general approach to guidance and standards under the new legislation; and
 - discard elements that will sit better in other guidance or codes being produced.
- 1.6 As part of the consultation the British Casino Association prepared a draft of this document. In addition to the consultation, a series of meetings were held with the British Casino Association (BCA) and Casino Operators' Association (COA) to discuss key principles, the draft, and to ensure the final document does not compromise any of the Commission's three licensing objectives. The Commission's response to the consultation was published in February 2007.

- 1.7** Following on from the consultation and Commission's response to the consultation this document, primarily written by the BCA with input from the COA, has been approved and published by the Commission.

Scope of the document

- 1.8** This document sets out the rules, including layouts, odds and any side bets, for each game on the list of approved games, or approved for trial.
- 1.9** The document has been created to ensure a consistent approach in providing casino games in Great Britain and accordingly is aimed at casino operators.
- 1.10** The Commission has approved the games (including side wagers) that are on trial from 1 September 2007. The Commission will decide whether these games should be included on the list of approved games when the trial period is complete. This document will be updated if these games are formally approved.
- 1.11** Any matters relating to game rules not specifically covered in this document may be interpreted at the discretion of the operator. The Commission's licence conditions and codes of practice require that all operators of these games have training, security, procedures and systems in place to ensure that all the games are played in an open and fair manner.

2. General rules

- 2.1 The following are standard non-remote casino house rules. The listed games may only be played for commercial gain on casino premises, licensed under the Act.

How to read this document

- 2.2 The text within the shaded boxes in this document relate to games and side wagers to be trialled from 1 September 2007 with the approval of the Commission.

Trial/introduction of new games and variations to existing games

- 2.3 Only the games detailed in this document may be played in British casinos. However, with the **prior** permission of the Commission, other games may be operated, or new features to existing games added, as a trial based on the rules listed:
- a) The game or variation must be put forward to the Commission through an operator licensed by the Commission, and made generally available for all Great Britain operators to participate in the trial.
 - b) The trial must only take place for a time period agreed in advance with the Commission and the new game or additional feature must be operated in accordance with draft practices, rules and odds agreed with the Commission beforehand.
 - c) Information as to how the game or feature is played, and the house edge involved, must be made available to players within the casino to ensure that all customers may understand the new game before participating.
 - d) If the industry wishes to pursue the game after the trial, a formal request must be made to the Commission at, or towards, the end of the trial period, for the game to be formally included in the list of approved games. The Commission will then decide whether the game may be formally introduced once it has considered the results of the trial and agreed the rules, minimum odds payable and maximum house edge with the industry.
 - e) At its discretion, the Commission may approve an extension to a particular trial. This might be, for example, to allow the game to continue uninterrupted between the end of the trial period and its formal adoption into this document, or otherwise to enable further information to be gathered and assessed before deciding whether to formally adopt the game.

- f) If the conduct of the game causes concern to the Commission at any time after the trial has commenced, play must be discontinued, either at the end of the trial period, or within a reasonable time otherwise agreed with the Commission.
- g) Alternatively, if the industry itself does not wish to pursue the game or variation, for whatever reason, play may be discontinued at any point within the trial period. Operators must notify the Commission if and when any trial is formally abandoned by the industry.
- h) Any application to trial or approve a new game or variation may only be made to the Commission through licensed operators. The Commission will not accept applications made directly to them by manufacturers, proprietors or suppliers of new games unless they can provide evidence that at least some section of the industry wishes to offer it to customers.

Local temporary variations to the practices and rules

2.4 In certain circumstances, it is permitted to make minor variations to the rules detailed in this document on a temporary and local basis. Examples might include a bonus payment or small additional feature made as part of a local promotion. Changes may only be introduced subject to the rules below:

- a) The Commission must be notified in writing of any amendments before any change is introduced, and the notification must include details as to the occasion(s), location(s) and period(s) of time that will be applied.
- b) Details of the temporary amendment are to be clearly highlighted to the players on all tables operating the game concerned.
- c) If the Commission considers that a proposed variation amounts to a significant change or additional feature to a game, it may require that the variation instead be put forward as a formal new game or variation, in accordance with rule 2.3 above.
- d) If at the end of the notified period of use, the local operator wishes to introduce the variation on a permanent basis, they may then apply to the Commission for the change to be formally approved as an agreed variation to the game concerned, and added to this document accordingly.
- e) Approval is not required for an operator to offer odds that are higher than the minimum odds prescribed in this document (ie offering a better return to the player). However, when odds other than the prescribed minimum odds or pay tables given in this document are offered, a sign or notice must be displayed at the table or tables concerned, including the house edge, so that players are made aware of this.

The bank

2.5 The following rules apply to **ALL** games listed in this document and cannot be varied:

- a) no person other than the holder of a licence under the Gambling Act 2005 for the premises where the game is played shall have any share or interest in the bank;
- b) the bank shall be held by the licence holder or a person acting in pursuance of a service agreement on their behalf; and
- c) all wagers will be made with the bank.

Fully and partly automated casino games

2.6 **ALL** equipment used in fully and partly automated casino games must comply with technical standards set by the Commission as stated in the document, *Bingo and Casino Equipment Technical Requirements*, published on 1 June 2007. Rules of such games cannot vary from those set out in this document without prior consent from the Commission.

Progressive side wagers

2.7 At the licence holder's discretion, a casino may introduce an additional feature into any game listed within this document, namely a 'Progressive Jackpot' wager, subject to specific rules and odds being detailed for that wager in the section relating to the game concerned. In such cases, the following standard rules will apply wherever a progressive jackpot wager is applied:

- a) operators will have systems and procedures in place to account for malfunctions and technical faults during the operation of the game;
- b) at least 70% of the total value of the progressive jackpot wagers placed at all tables, within the premises and at any tables on other premises, which are linked for the purposes of the progressive jackpot, shall be added to a cumulative prize fund (referred to in these rules as the 'Progressive Jackpot Meter');
- c) a licence holder may apply additional sums to the progressive jackpot meter (the Jackpot 'seed') from its own funds;
- d) equipment used to play the progressive wager must conform to the technical standards stated in the document, *Bingo and Casino Equipment Technical Requirements*, published on 1 June 2007 by the Commission;
- e) operators must have procedures in place to account for the possibility of multiple wins occurring at the same time, either on the same table, same premises or premises located elsewhere that are linked into the same progressive jackpot meter;
- f) operators must have procedures and security systems in place to ensure the integrity of the funds held on the progressive jackpot meter, and to ensure that any wins can be substantiated to the satisfaction of the Commission; and
- g) a sign or notice must be displayed at each participating table showing the current progressive jackpot meter total.

Minimum odds and pay tables

- 2.8** Odds detailed in this document refer to the minimum odds that must be offered to players within a game. As detailed in rule 2.4e, more favourable odds may be offered to the player, on a permanent or temporary basis, provided the details are clearly displayed at the table.
- 2.9** However, whilst the minimum odds permissible for each individual wager are detailed in this document, operators may wish to change the whole pay table, rather than simply adjust one or more individual odds. This is in order to balance the house edge across the whole range of odds being applied. It is acceptable to replace complete pay tables in this way provided:
- a) the individual odds used within a pay table are not less than the individual minimum odds given within this document;
 - b) house edge details relating to every pay table used in a particular premises are made clearly available to players;
 - c) for the benefit of players, a sign or notice is displayed at each relevant gaming tables indicating which pay table is being used, so that players may compare the given odds against details of the house edge otherwise made available within the premises; and
 - d) where a pay table is used that increases the minimum odds, but is otherwise not one of the pre-determined tables prescribed in both this document and the House Edge leaflet, the sign or notice also shows the revised house edge for the game resulting from the revised pay table.
- 2.10** In some cases, the minimum odds given in this document serve only to show the lowest permitted odds, drawn from all of the pay tables listed for that game. As a result, the minimum odds are not always in themselves a well-balanced pay table. In such cases, this fact is indicated in the description of the minimum odds within this document, with a recommendation that one of the given pay tables is used.

3. Roulette

The table layouts

3.1 Figures 1 and 2 show examples of the style of game layouts that may be offered to the players. They also illustrate the full range of bets available, and the position that such bets must be placed on the layout, in accordance with the list given in paragraph 3.2.

Figure 1: American roulette

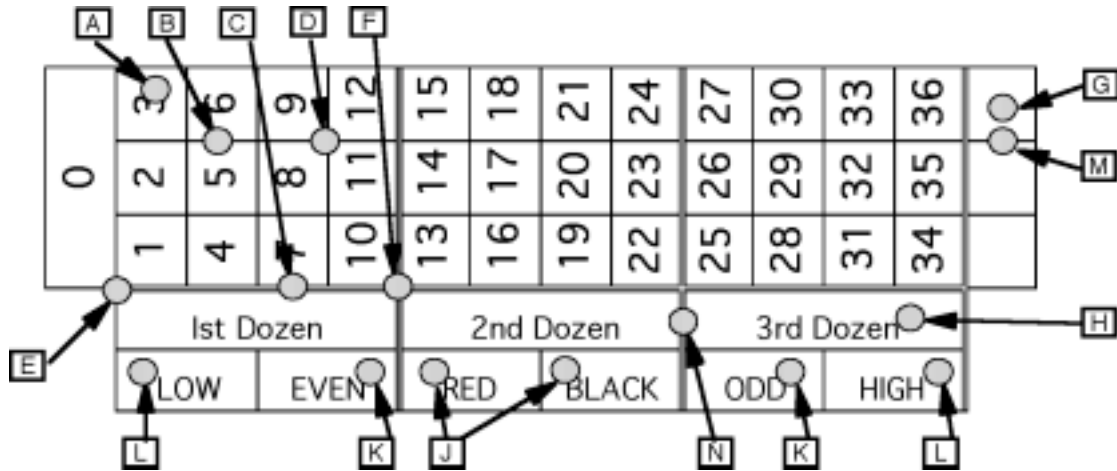
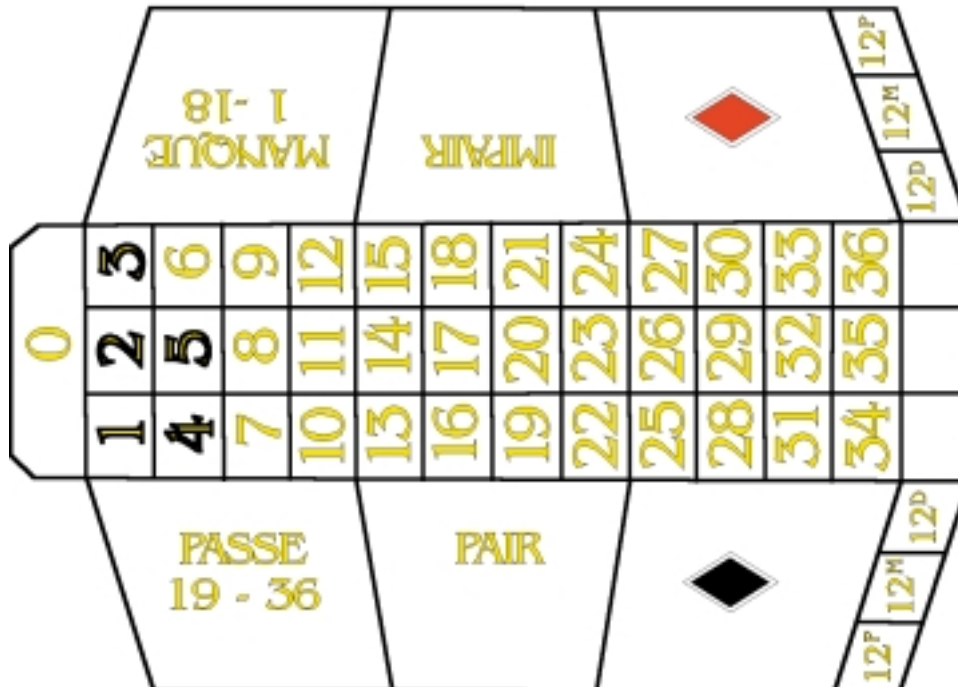

Figure 2: French roulette



3.2 Any wager in relation to this game shall be payable, if won, at a minimum and with the odds indicated below:

American term	French term	Minimum odds
A. Straight Up – one specific number	En Plein	35 to 1
B. Split – one of two specific numbers	A Cheval	17 to 1
C. Street – one of three specific numbers	En Transversale	11 to 1
D. Corner – one of four specific numbers	En Carré	8 to 1
E. First Four – one of numbers 0,1,2,3	Quatre Premiers	8 to 1
F. Six Line – one of six specific numbers	Sixain	5 to 1
G. Column – one of 12 specific numbers in a row	Sur une Colonne	2 to 1
H. Dozen – one of 12 specific numbers in a block	Sur une Douzaine	2 to 1
I. Red or Black – one of 18 specific numbers	Rouge ou Noir	1 to 1
J. Odd or Even – one of 18 specific numbers	Impair ou Pair	1 to 1
K. Low or High – one of 18 specific numbers	Manque ou Passe	1 to 1
L. Split Columns – one of 24 specific numbers in a row	A Cheval sur Deux Colonnes	1 to 2
M. Split Dozens – one of 24 specific numbers in a block	A Cheval sur Deux Douzaines	1 to 2

3.3 When the winning number is zero:

- a) wagers placed on zero, or combination of zero with one, two and/or three, shall win at odds in accordance with rule 3.2;
- b) half of each wager on any even money chance shall be lost and the remaining half returned to the player; and
- c) the whole of all other wagers shall be lost.

3.4 It is not a requirement that all wagers are made available on any particular table. However, no variation may be considered in addition to the wagers and minimum odds given in rule 3.2, other than in accordance with the rules detailed in section 2.3 and 2.4.

The wheel

3.5 Other than any permitted variations detailed in rule 3.11 onwards, or otherwise in accordance with the rules detailed in section 2.3 and 2.4, the wheel used to play roulette shall have 37 equal sized compartments with one marked zero and the others marked 1 to 36, coloured alternately red and black, and in the same sequence as shown in Figure 3 below.

Roulette Rage side wager

- 3.12 It is at the discretion of the licence holder whether or not to offer an additional feature called 'Roulette Rage' as an additional wager within a standard game of roulette. The proprietor of the side wager is TCSJohnHuxley Ltd and no variations may be put forward without their prior agreement.
- 3.13 The feature shall only be made available at a table or tables marked for the provision of the wager.
- 3.14 The Roulette Rage side wager is an optional wager that at least five consecutive numbers will be spun of the same colour. Higher odds are paid depending on the number of consecutively coloured numbers that are spun.
- 3.15 Wagers on the Roulette Rage side wager may only be placed after a different coloured number is spun to that spun immediately before it. For example, when a black number is spun after one or more red numbers.
- 3.16 Further wagers may not then be placed until a sequence of consecutive colours is broken by a number of a different colour being spun, or by zero, whichever is spun first.
- 3.17 The Roulette Rage side wager is not activated if zero is spun, which will be deemed to bring a previous consecutive sequence to an end. New wagers may only then be placed after a further number has been spun following the zero, or multiple zeros.
- 3.18 When a different coloured number is spun (as per rule 3.15), the dealer will invite all players at the table to place optional wagers on the Roulette Rage side wager, within the specified table limits. The first spin that determines the colour for the Roulette Rage side wager will hereafter be known as the 'establishing spin'. This spin **will not** count towards the sequence of consecutive colours (ie the first number will register only if the establishing colour is repeated on the next spin).
- 3.19 Players need not have placed any other wager within the game in order to place a Roulette Rage side wager.
- 3.20 All Roulette Rage side wagers will be placed in the betting area marked for the purpose by the dealer after the establishing spin. No further side wagers may be accepted until the next establishing spin.
- 3.21 The roulette game will then continue as normal.
- 3.22 If a first number spun after the establishing spin is of the same colour, all Roulette Rage wagers will be moved into the circle marked '1', other than where rule 3.23 applies.
- 3.23 Operators may choose to have the current number of consecutive spins transmitted automatically from the wheel to an electronic number display.

Provided players are able to clearly see the current number on the display, it is not then necessary to physically move the wagers from the betting area. This applies to all subsequent spins up to 15.

3.24 If the next number spun is not of the same colour as the establishing spin, then all Roulette Rage wagers will be lost and surrendered to the house. A new round of wagers may then be accepted, in accordance with rules 3.18 and 3.19.

3.25 If a second number of the same colour is spun after the establishing spin, all Roulette Rage wagers will be moved into the circle marked '2'. The same process continues on the next two spins, whereby all roulette rage wagers will be moved into the circle marked '3' or '4' respectively.

3.26 Rule 3.24 will apply if a different coloured number, or zero, is spun on either the first, second or third spin after the establishing spin. However, if the fourth spin after the establishing spin is the same colour, then all Roulette Rage wagers will win and qualify for a pay out as and when a different colour or zero is subsequently spun. The pay out will then relate to however many spins of the same colour had occurred before the sequence was broken. For example, if five red numbers are spun after the establishing spin, followed by a black number, the winning wagers will be paid the odds for five consecutive colours given in rule 3.28.

3.27 Wagers will only be paid out if the odds applicable for the highest number of consecutive spins are achieved, up to a maximum of 15, including the establishing spin. Any consecutive spins thereafter will not be counted. Rule 3.18 will then apply as soon as a different colour is spun, at which time winning wagers will be paid odds for 15 consecutive spins.

3.28 Winning Roulette Rage wagers will be paid the following minimum odds for achieving at least four consecutive spins of the same colour, after the establishing spin:

Number of consecutive spins of the same colour (after establishing spin)	Minimum odds
4	5 to 1
5	8 to 1
6	15 to 1
7	20 to 1
8	40 to 1
9	60 to 1
10	100 to 1
11	200 to 1
12	400 to 1
13	1000 to 1
14	2000 to 1

3.29 The above table shows the minimum permitted odds that may be paid for each consecutive spin, drawn from the pay tables given in this section.

3.30 However, the full list of minimum odds is not, in itself, a well-balanced pay table and in fact carries a house edge of 17.0%. It is therefore recommended that the minimum odds are only used as a guide and not as a pay table in themselves.

3.31 In addition to offering the minimum odds given in rule 3.28, odds for winning Roulette Rage wagers may be presented as complete pay tables, in accordance with rule 2.9 given in section 2. Permitted pay tables are as follows:

Pay table 1

Number of consecutive spins of the same colour	Minimum odds
4	6 to 1
5	10 to 1
6	20 to 1
7	30 to 1
8	40 to 1
9	60 to 1
10	100 to 1
11	200 to 1
12	400 to 1
13	1000 to 1
14	2000 to 1

Pay table 2

Number of consecutive spins of the same colour	Minimum odds
4	5 to 1
5	9 to 1
6	20 to 1
7	30 to 1
8	40 to 1
9	60 to 1
10	100 to 1
11	200 to 1
12	400 to 1
13	1000 to 1
14	2000 to 1

4. Blackjack

The table layouts

- 4.1 Figures 4 and 5 show examples of the style of game layout that may be offered to players.

Figure 4

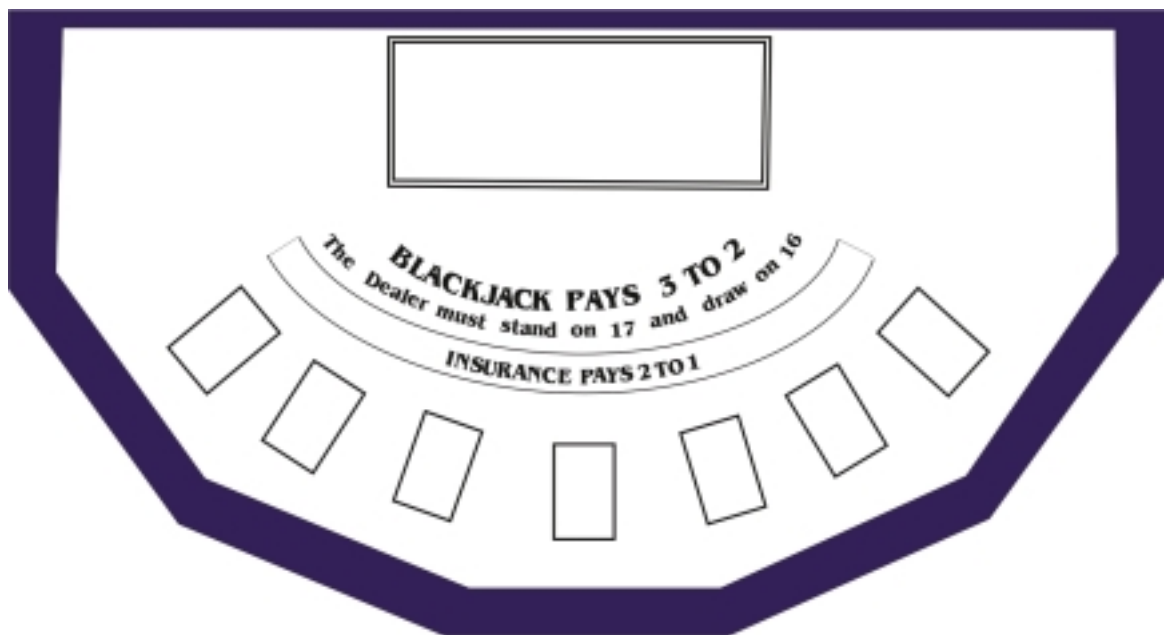
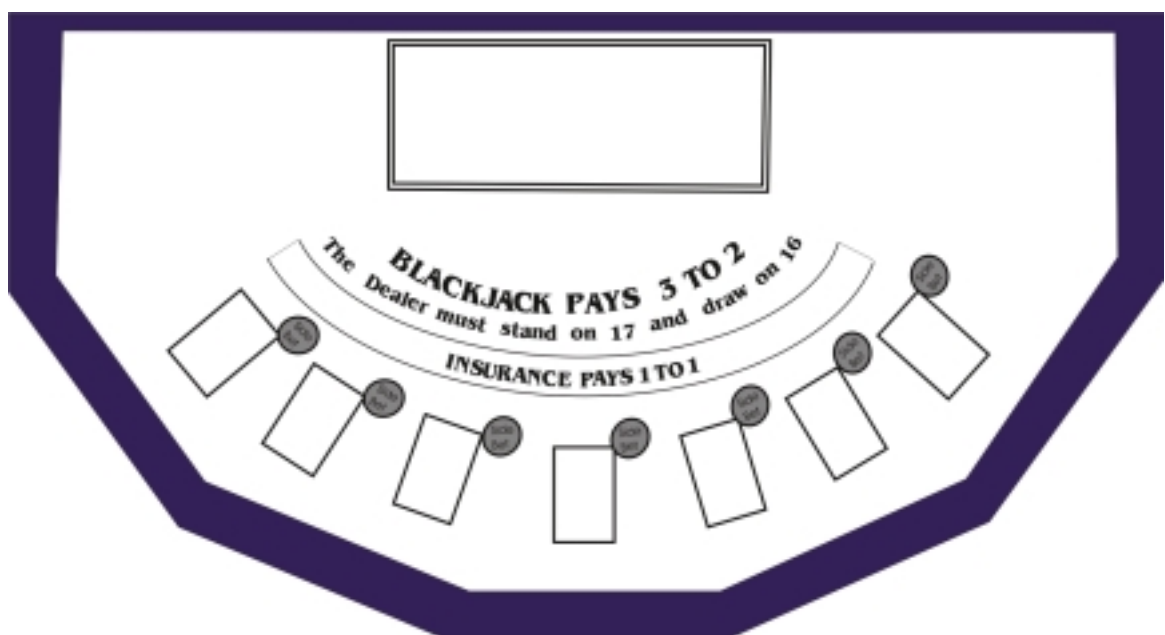

Figure 5



- 4.2 The layout must show any additional side wagers permitted by these rules, in cases where those wagers are made available on the table concerned. If an optional side wager is marked on the layout, the wager must be offered to the players, unless a sign is clearly displayed on the table stating that the wager is not available, for whatever reason. Similarly, the wager may not be accepted if the feature is not marked on the table layout.
- 4.3 Only side wagers listed in rules 4.31 and onwards of this section are permitted, unless agreed with the Commission in accordance with the rules detailed in section 2.3 and 2.4.

General rules

- 4.4 The number of decks of cards in use on each table shall not change, other than at the end of a shoe, and then with the unanimous agreement of all players currently participating in the game. The number of decks used may not be changed during a shoe or at any time when the change is likely to be inequitable to a player or group of players.
- 4.5 A sign or notice specifying the number of decks in play must be displayed at the table. Unless the house edge for the number of decks used is otherwise detailed in the House Edge leaflet, the house edge applicable to the number of decks in play must be displayed on the sign or notice.
- 4.6 Certain side bets detailed in rules 4.31 onwards may **only** be offered where four or six decks are in use.
- 4.7 Operators must have procedures in place to ensure the security and integrity of the cards.
- 4.8 The maximum and minimum wagers permitted shall be shown on a notice prominently displayed at the table. Partnerships with a view to exceeding the maximum stake shall not be permitted.
- 4.9 The cards are dealt face up so that they are disclosed immediately to all of the players. Each opposing player will receive two cards as their 'initial deal', starting with the player to the dealer's left.
- 4.10 One card only is dealt to the dealer as their initial deal in any game. The dealer's card is dealt before any opposing player is asked whether or not they require a third or any subsequent card dealt to their hand.
- 4.11 The values of the cards dealt to any hand are as follows:
- a) the first Ace dealt to any one player in any game has the value of 11 unless that would give the player a score of more than 21 at the end of the game and, subject to that, any Ace has the value of 1;
 - b) any card from 2 to 10 has its face value;
 - c) any Jack, Queen or King has a value of ten; and
 - d) any Ace together with a 10, Jack, Queen or King shall constitute a blackjack (ie a total card count of 21 with just two cards) but a blackjack cannot be obtained in any hand that is derived from splitting a pair, or pairs.

- 4.12** An opposing player is not required to take a third or any subsequent card if they do not wish to do so.
- 4.13** An opposing player who achieves a score of 21, either with a hand of two cards only (blackjack), or with a combination of additional cards, is not permitted to take any further cards.
- 4.14** Subject to rule 4.15, the dealer is required to draw further cards on their own hand when they have a score of 16 or less and is not permitted to take a further card once they have a score of 17 or more.
- 4.15** Management may decide which of the following two options will apply to the dealer's hand:
- The first Ace dealt to the dealer in a game shall have a value of 11. If this gives a total of between 17 and 21 inclusive, the dealer must stand. For example, an Ace and 6 equals a score of 17. Alternatively, if this would give a score of more than 21 at the end of the game, and subject to that, an Ace shall have a value of 1;
 - 'Soft 17' – an Ace dealt to a dealer's hand will count as 11, unless this gives a score of more than 21, or a total of 17, in which case it will count as one. Therefore, an Ace and 6 will equal 7, and not 17. If it gives a total of between 18 and 21 inclusive, the dealer must stand.

Where option b) is used, a notice must be displayed on the table clearly stating this fact.

Wagers and settlement

- 4.16** Wagers on a participating player's hand shall be wagers that the hand will achieve a score not exceeding 21, and will win if either:
- the dealer's score exceeds 21; or
 - the player achieves a higher score than the dealer using either the two cards initially dealt or those cards combined with any further cards subsequently drawn to the hand; or
 - the player and the dealer both achieve a score of 21, but the player does so with a hand of two cards only, and the dealer does not.
- 4.17** The hand and wager shall be treated as void if the player and the dealer:
- both achieve the same score that is less than 21;
 - both achieve a score of 21 with a hand of two cards only; or
 - both achieve a score of 21 with more than two cards.
- 4.18** Subject to rules 2.3 and 2.4, a winning hand in accordance with rule 4.16 shall be paid minimum odds as follows:
- where the player achieves a winning score of 21 with a hand of two cards only (blackjack), the hand will be paid at **3 to 2**; and
 - in any other case, the hand will be paid at **1 to 1**.

Insurance

- 4.19** When the dealer's first card is an Ace, any player who has a score of 21 with the first two cards (blackjack) may wager an amount equivalent to no more than half the amount staked on his initial wager that the dealer's second card will have a value of 10. Any wager which wins under this rule shall be payable at odds of **2 to 1**. All insurance wagers shall be made before a third card is dealt to any box (the subsequent deal).
- 4.20** Alternatively, when the dealer's first card is an Ace, any player who has a score of 21 with their first two cards (blackjack) may be offered the option of being paid at odds of 1 to 1 immediately. This has the same net effect as a winning wager of half the original stake winning at odds of 2 to 1, under rule 4.19.
- 4.21** During the subsequent deal, where the dealer's second card is not a 10, any insurance wagers under rule 4.19 which remain unsettled shall be lost, and should be collected by the dealer immediately after the drawing of that card.

'Playing behind'

- 4.22** Decisions on the hand dealt to any particular playing position shall be made by the person seated at that position (the 'controlling player'), provided they have placed an initial wager on that position. Further players may place wagers on the same playing position ('playing behind'), but may not make decisions on the hand and must abide by the decisions made by the controlling player.
- 4.23** Wagers placed by people playing behind will win or lose in accordance with the outcome of the hand dealt to the controlling player in accordance with rules 4.16, 4.17 and 4.18.

Doubling down

- 4.24** The player may double the amount of their initial stake, on the condition that they receive a third card and no more. Where the controlling player decides to double down in this way, players who are 'playing behind' on that hand may similarly double their wager, but the hand will receive only one more card, irrespective of whether they decide to do so.

Management may decide which of the following options will apply:

- a) the double down option will only be offered where the player has a score of 9, 10 or 11; or
- b) the double down option will be offered when the player has any score.

Where option b) is used, this must be displayed on a sign or notice at the table.

Splitting pairs

- 4.25** Where the first two cards dealt to an opposing player's hand are cards of equal value (ie a pair), that player may elect to split the two cards into two separate hands. They must then make a further initial wager, equal to that already staked, on the second hand so formed.

Management may decide which of the following options will apply:

- a) the option to split a pair will not apply when the player has a pair of 4s, 5s or 10s); or
- b) the option to split will apply to any pair.

Where option b) is used, this must be displayed on a sign or notice at the table.

- 4.26 The dealer will then deal a second card to each of the split cards which will be treated as separate hands. However, if the two cards being split are both Aces, the two cards being formed will only receive one further card each.
- 4.27 A two-card total of 21 formed by a split hand in conformity with these rules will not constitute a blackjack, but will count as a score of 21 and be paid at odds of 1 to 1 if the hand wins.
- 4.28 The player will complete the first split hand before electing to draw cards to the second hand. If the cards dealt to a split hand result in a further pair of cards of equal value, the resulting pair may be split again and continue to be split if the resulting hand(s) contain cards of the same value.
- 4.29 Any person who is playing behind on the playing position, on which the controlling player has elected to split a pair, will also have the option of making a wager of an equal amount on the second hand. If they chose not to do so, they must identify on which of the two hands they wish their wager to be applied, either remaining on the original hand, or being transferred onto the second split hand if they prefer.
- 4.30 On a hand formed as a result of a split pair, players on that hand have the option of doubling their wager in accordance with rule 4.24.

Permitted variations to blackjack

'21+3'

- 4.31 It is at the discretion of the licence holder whether or not to offer an additional feature called '21+3' as an additional wager within the standard game of blackjack. The proprietor of the side wager is Prime Table Games and no variations may be put forward without their prior agreement.
- 4.32 The feature shall only be available at a table or tables marked for the provision of the wager. The wager **may only be offered where four or six decks are in use.**
- 4.33 '21+3' is an optional wager that the first two cards dealt to the hand to which the wager relates will, when combined with the **first** card dealt to the dealer's hand, make a three card poker hand against the following list of winning hand:

Flush	All three cards of the same suit (eg three Hearts, three Clubs etc).
Straight	All three cards in sequence, but not of the same suit (eg 4 of Hearts, 5 of Diamonds and 6 of Clubs. Please note, this includes both Ace, 2, 3 and Queen, King and Ace).
Three of a Kind	All three cards of the same rank (eg three 2s, three Queens etc).
Straight Flush	All three cards in sequence and of the same suit (eg 4, 5 and 6 of Hearts. Please note, this includes both a sequence of Ace, 2 and 3 or of Queen, King and Ace).

Note: A Flush may include Three of a Kind within it, but this will count as only one winning hand.

- 4.34** If **any** of the hands given in section 4.33 is so formed, then any '21+3' winning wagers placed on the related hand will be paid odds at a minimum of **9 to 1**.
- 4.35** If none of the hands given in section 4.33 is so formed, then any '21+3' wagers placed on the related hand will lose.
- 4.36** The playing of a '21+3' wager shall not otherwise affect the manner in which a player may choose to play his hand in accordance with the practices and rules for blackjack given in this section.
- 4.37** A '21+3' wager may only be placed if the player has also placed a standard initial blackjack wager on the hand concerned.
- 4.38** All '21+3' wagers will be settled immediately after the initial deal, before any decisions are made, or further cards are dealt to the main blackjack game.

'Royal Match'

- 4.39** It is at the discretion of the licence holder whether or not to offer an additional feature called 'Royal Match' as an additional wager within a standard game of blackjack. The proprietor of the side wager is Shufflemaster Inc. and no variations may be put forward without their prior agreement
- 4.40** The feature shall only be available at a table or tables marked for the provision of the wager. **The wager may only be offered where four or six decks are in use.**
- 4.41** 'Royal Match' is a wager that the first two cards dealt to a hand to which the wager relates will both be of the same suit.
- 4.42** If both cards in a hand to which the wager relates are of the same suit, they will win and be paid, as a minimum, the range of odds shown below, depending on the value of the cards concerned:

Hand	Minimum odds
Royal Match – King and Queen of the same suit	30-1
Suited Pair – eg two 9s, 7s of the same suit	8-1
Straight Flush – two consecutive cards of the same suit	4-1
Two suited cards – any two cards of the same suit	3-2

Please note that the above table shows the minimum permitted odds that may be paid, drawn from the pay tables given in section 4.43. However, the full list of minimum odds is not, in itself, a well-balanced pay table and in fact carries a house edge of between 10.2% and 11.5% depending on whether four or six decks are used. It is therefore recommended that they are only used as a guide and not as a pay table in themselves.

- 4.43** In addition to offering, as a minimum, the odds given in rule 4.42 above, odds may be presented as complete pay tables, in accordance with rule 2.9. Permitted pay tables are as follows:

Pay table 1

Royal Match	30-1
Suited Pair	9-1
Straight Flush	5-1
Two suited cards	3-2

Pay table 2

Royal Match	40-1
Suited Pair	8-1
Straight Flush	4-1
Two suited cards	3-2

- 4.44** If the first two cards dealt to a related hand are not of the same suit, then any related wagers placed on the Royal Match side wager for that hand will lose.
- 4.45** The playing of a Royal Match wager shall not otherwise affect the manner in which a player may choose to play his hand in accordance with the practices and rules for blackjack given in this section.
- 4.46** A Royal Match wager may only be placed if the player has also placed a standard initial blackjack wager on the hand concerned.
- 4.47** All Royal Match wagers will be settled immediately after the initial deal, before any decisions are made or further cards are dealt to the main blackjack game.

'Perfect Pairs'

4.48 It is at the discretion of the licence holder whether or not to offer an additional feature called 'Perfect Pairs' as an additional wager within a standard game of blackjack. The proprietor of the side wager is TCSJohnHuxley Ltd and no variations may be put forward without their prior agreement.

4.49 The feature shall only be available at a table or tables marked for the provision of the wager. **The wager may only be offered where four or six decks are in use.**

4.50 Perfect Pairs is a wager that the first two cards dealt to a hand to which the wager relates will be a pair of the same value.

4.51 If both cards dealt to a hand to which the wager relates are a pair of the same value (eg two 3s, two Queens etc) they will win and be paid, as a minimum, the range of odds shown below, depending on the suits and colours of the cards concerned:

Hand	Minimum odds
Mixed Pair – one red, one black	5-1
Coloured Pair – both red or black, but different suits	10-1
Perfect Pair – both of the same suit	25-1

Please note that the above table shows the minimum permitted odds that may be paid, drawn from the pay tables given in section 4.52. However, the full list of minimum odds is not, in itself, a well-balanced pay table and in fact carries a house edge of between 11.5% and 13.8%, depending on whether four or six decks are used. It is therefore recommended that they are only used as a guide and not as a pay table in themselves.

4.52 In addition to offering, as a minimum, the odds given in rule 4.51 above, odds may be presented as complete pay tables, in accordance with rule 2.9. Permitted pay tables are as follows:

Pay table 1 (recommended by proprietor for four deck game)

Mixed Pair	5-1
Coloured Pair	12-1
Perfect Pair	30-1

Pay table 2 (recommended by proprietor for a six deck game)

Mixed Pair	5-1
Coloured Pair	10-1
Perfect Pair	30-1

4.53 If the first two cards dealt to a related hand are not a pair, then any related wagers placed on the Perfect Pairs side wager for that hand will lose.

- 4.54 The playing of a Perfect Pairs wager shall not otherwise affect the manner in which a player may choose to play his hand in accordance with the practices and rules for blackjack given in this section.
- 4.55 A Perfect Pairs wager may only be placed if the player has also placed a standard initial blackjack wager on the hand concerned.
- 4.56 All Perfect Pairs wagers will be dealt with immediately after the initial deal, before any decisions are made or further cards are dealt to the main blackjack game.

5. Three Card Poker

The table layouts

- 5.1 Three Card Poker is a proprietary game licensed in the UK by the registered proprietor, Prime Table Games. Figure 6 shows a layout design approved by the registered owner, which must be offered to players in all formats of the game offered in the UK, unless otherwise agreed with the proprietor.

Figure 6

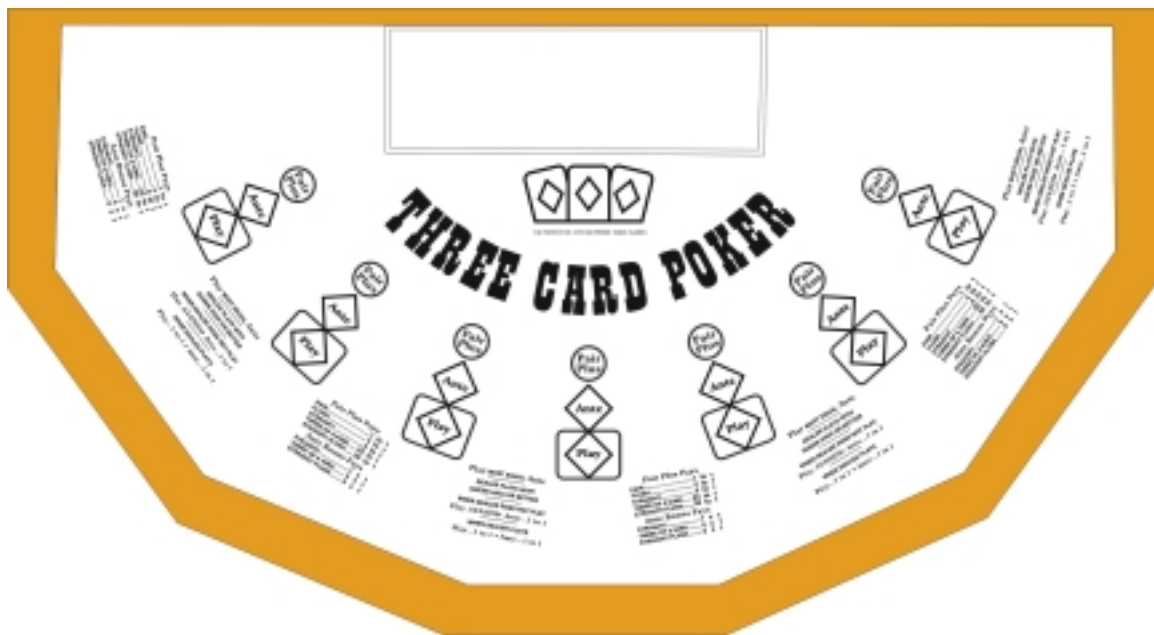

- 5.2 Only side bets listed in rules 5.24 and onwards in this section are permitted, unless agreed by both the Commission, in accordance with the rules detailed in section 2.3 and 2.4, and with the agreement of the proprietor.

General rules

- 5.3 The game shall be played with a single deck of cards.
- 5.4 Operators must have procedures in place to ensure the security and integrity of the cards.
- 5.5 The maximum and minimum wagers permitted shall be shown on a notice prominently displayed at the table. Partnerships with a view to exceeding the maximum stake shall not be permitted.
- 5.6 The payout odds for the Ante Bonus and Pair Plus shall be printed on the layout in accordance with a design approved by the registered owner or, where approved by the registered owner, shown on a sign or notice displayed at the table.

- 5.7** The relative value of each of the cards is as follows (in descending order): Ace, King, Queen, Jack, 10, 9, 8, 7, 6, 5, 4, 3, 2, except that the Ace may be used as a value of one in order to complete a Straight Flush or a Straight, as defined in rule 5.8 below (being 3, 2, Ace).
- 5.8** The terms used to describe the hands held by a participant in the game, and the ranking of hands from highest to lowest, are as follows:
- i) **Straight Flush** – three cards of consecutive values of the same suit;
 - ii) **Three of a Kind** – three cards of the same value;
 - iii) **Straight** – three cards of consecutive values not being a straight flush;
 - iv) **Flush** – three cards of the same suit not being a straight flush;
 - v) **Pair** – two cards of the same value; and
 - vi) **High card** – the highest value single card.

Initial wager

- 5.9** Only one wager may be accepted on each playing position and no individual player may place a wager on more than one playing position.
- 5.10** An initial wager (comprising either, or both, of the wagers referred to in rule 5.11 i) and ii), below, as respectively an Ante wager and/or a Pair Plus wager) shall be made by each opposing player in the appropriate playing position, before any cards are dealt in the game.
- 5.11** Each opposing player may place either one, or both, of the following wagers:
- i) A Pair Plus wager, being a wager that the player's hand will achieve a particular hand ranking, irrespective of the hand dealt to the dealer.
 - ii) An Ante wager, being a wager that the player's hand will have a higher ranking than the dealer's hand.
- 5.12** Each player and the dealer will be dealt three cards face down, starting with the player to the dealer's left.

Subsequent deal

- 5.13** An opposing player, who has made an Ante wager and who wishes to continue with that wager after the cards are dealt, shall make a further wager (referred to in these rules as a 'Play' wager) which must be of an equal amount to his Ante wager. They will place their cards in the 'Play' area with the wager on top.
- 5.14** An opposing player who has made an Ante wager but who does not make a subsequent 'Play' wager shall surrender the amount staked on the Ante wager to the bank.
- 5.15** A player who has **only** placed a Pair Plus wager (without also placing an Ante bet) will place their cards in the 'Play' area (this time without a wager on top) if their hand contains at least a pair.

- 5.16** The dealer's hand must have a value of 'Queen high' or better to qualify to play against the player's hands.
- a) If the dealer **does not** have a qualifying hand:
 - i) all 'play' bets are declared void and returned to the players;
 - ii) Ante bonuses are paid on all Straights or better;
 - iii) all Ante bets are won by the players and paid at the rate of **1 to 1**; and
 - iv) all Pair Plus wagers are paid or taken.
 - b) If the dealer **does** have a qualifying hand:
 - i) the 'play' wagers are paid or taken;
 - ii) Ante bonuses are paid on all Straights or better;
 - iii) Ante bets are paid or taken; and
 - iv) Pair Plus wagers are paid or taken.
- 5.17** If after ranking the cards, the first two cards in the dealer's hand tie with a player's hand, the third card will determine the winner. A tied hand is a stand-off on the 'Play' and on the 'Ante'. However, the Ante Bonus and the Pair Plus wagers are always paid, where applicable.
- 5.18** If a player's hand beats the dealer's qualifying hand, the player wins on their Ante and Play wagers, both of which are paid at **1 to 1**.
- 5.19** If the dealer's hand has a higher poker ranking than the player's hand, in accordance with rule 5.8, the player loses both their Ante and Play wagers.
- 5.20** An opposing player who has made an Ante wager and a Play wager shall be paid an Ante Bonus, payable in respect of his Ante wager only and at the minimum odds set out in this rule, if, upon his hand being revealed, his hand consists of one of the following hands, as defined in rule 5.8:
- a) **Straight** – player will be paid at minimum odds of **1 to 1**
 - b) **Three of a Kind** – player will be paid at minimum odds of **4 to 1**
 - c) **Straight Flush** – player will be paid at minimum odds of **5 to 1**
- 5.21** If both an opposing player's hand and the dealer's hand are of exactly equal ranking, the Ante and Play wagers on that hand shall be void.
- 5.22** The wager of an opposing player who has made a Pair Plus wager shall win and be paid at the following minimum odds if, upon his hand being revealed, it consists of one of the following rankings:
- a) **Pair** – player will be paid odds of **1 to 1**
 - b) **Flush** – player will be paid odds of **4 to 1**
 - c) **Straight** – player will be paid odds of **6 to 1**
 - d) **Three of a Kind** – player will be paid odds of **33 to 1**
 - e) **Straight Flush** – player will be paid at odds of **35 to 1**

- 5.23** The wager of an opposing player who has made a Pair Plus wager shall lose and the amount staked be surrendered to the bank if, upon his hand being revealed, his hand does not contain at least a Pair.

Permitted variations to three card poker

- 5.24** Any permitted variations to the existing game will be listed here onwards. There are none at present.

6. Punto Banco

The table layouts

6.1 Figures 7 and 8 show examples of the style of game layouts that may be offered to players. They also illustrate the full range of wagers available, and the position at which such wagers must be placed using the example playing positions.

Figure 7: Full Size Punto

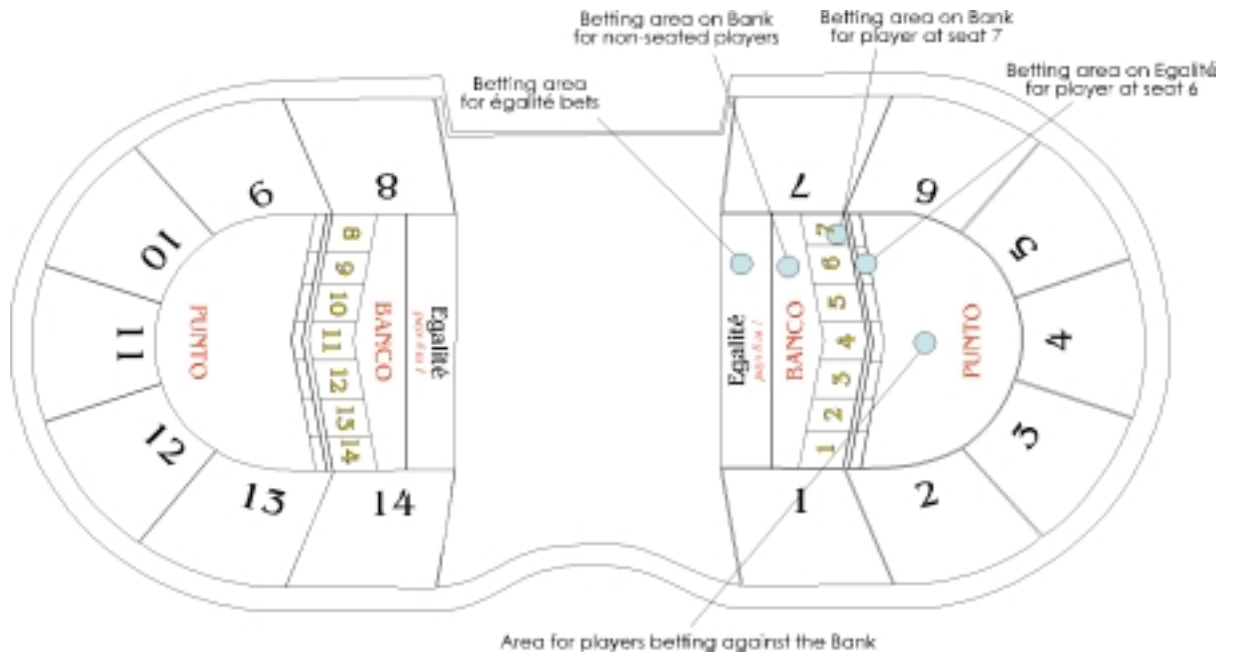
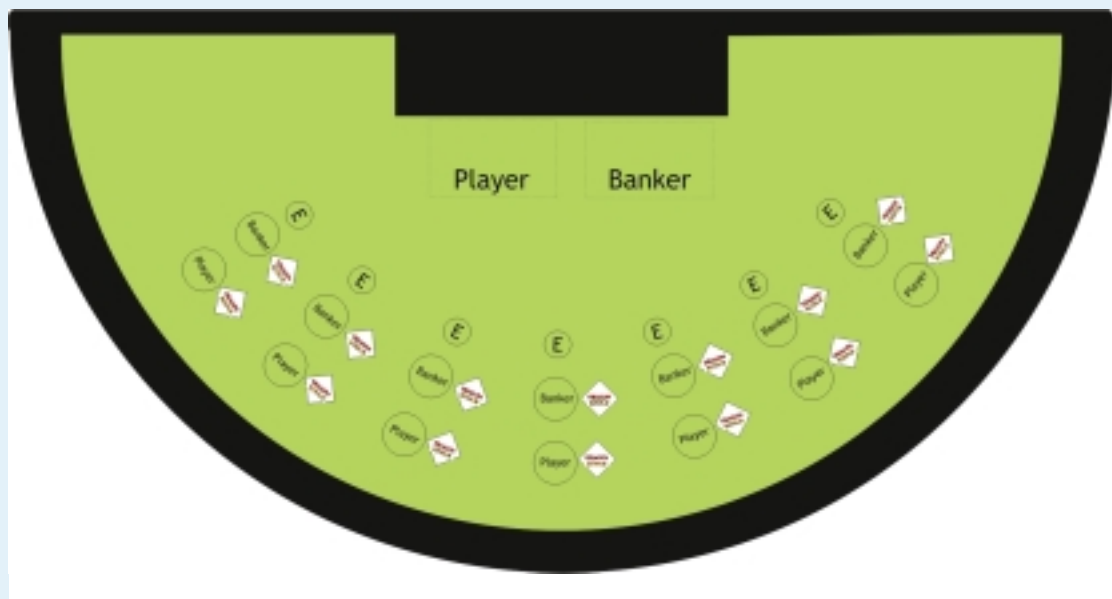

Figure 8: Mini Punto with Dragon Bonus side wager



Only side wagers or variations listed in rules 6.28 and onwards in this section are permitted, unless agreed with the Commission in accordance with the rules detailed in section 2.3 and 2.4.

The banker

- 6.2 There are two different methods of determining who is to fulfil the role of 'banker' within the context of the game, as follows:
- a) The dealer will at all times draw the cards and act as banker; or
 - b) The shoe will be offered in turn to each player seated at the table, who will accept or refuse to take on the role of banker.
- 6.3 If the dealer is to act as banker, they will at all times retain the shoe and deal the cards into predetermined positions on the table in front of them.
- 6.4 If the players are to act in turn as banker, the shoe will be offered anti-clockwise around the table to the seated players, starting at the commencement of play with the player in seat 1.
- 6.5 A player accepting the shoe shall act as banker **ONLY** for the purposes of dealing the cards, and will not hold or control the bank itself, in accordance with rule 2.5 of section 2.
- 6.6 If the bank loses in any coup, the shoe will be offered anti-clockwise around the table, starting with the player seated at the next numbered position.
- 6.7 Only players seated at numbered places may take the shoe. A new shoe will be regarded as a continuation of the previous shoe so far as transfer is concerned.
- 6.8 A player who has accepted the shoe may elect to wager on Egalité (a tied hand) only.
- 6.9 A player who has accepted the shoe may pass it after any coup.

The punter

- 6.10 The dealer shall act as the punter for all coups regardless of whether they are also acting as banker.

General rules

- 6.11 The number of decks in use on each table shall not change except at the end of the shoe, and then with the unanimous agreement of all players currently participating in the game. The number of decks used may not be changed during a shoe or at any time when the change is likely to be inequitable to a player or group of players.
- 6.12 Operators must have procedures in place to ensure the security and integrity of the cards.

- 6.13 The maximum and minimum wagers permitted shall be shown on a notice prominently displayed at the table. Partnerships with a view to exceeding the maximum stake shall not be permitted.
- 6.14 Wagers orally declared shall be accepted only if accompanied by the placing of sufficient chips or cash on the table to cover the wager and verbally confirmed by the dealer and/or the banker.
- 6.15 The count value of each Ace shall be one, the value of picture cards shall be ten, with the other cards having count values in accordance with the markings.
- 6.16 Hands shall comprise either two or three cards, according to the Table of Play (the 'Tableau') as detailed in rule 6.27.
- 6.17 The point value of a hand shall be a single figure (0-9 inclusive) and shall be determined by totalling the count values of the cards in the hand, and as requisite, subtracting ten or multiples of ten. A point of zero shall be termed 'Baccarat'.
- 6.18 Winning wagers on 'Banco' shall be paid, as a minimum, odds of **19 to 20**.
- 6.19 Winning wagers on 'Punto' shall be paid, as a minimum, odds of **1 to 1**.
- 6.20 Winning wagers on Egalité shall be paid, as a minimum, odds of **8 to 1**.

The initial deal

- 6.21 For each coup the banker shall initially deal four cards in the sequence punter, banker, punter, banker.

The play

- 6.22 After the initial deal, the value of the punter's hand will be determined and, depending on the point value, the punter will proceed as follows:

Point value	Action
'Baccarat', 1, 2, 3, 4 or 5	Punter takes an additional card face upwards
6 or 7	Punter stands
8 or 9	Punter stands

- 6.23 If either the punter or banker has a point of 8 or 9, the banker will deal no more cards for that coup.
- 6.24 If neither the punter nor the banker has a point of 8 or 9 on the Initial Deal, the banker shall, in accordance with the Table of Play in rule 6.27, either draw a card for his hand, or stand, as required.

6.25 The order of merit of hands at the conclusion shall be:

1. A two card point of nine
2. A two card point of eight
3. A three card point of nine
4. A three card point of eight
5. A two card or three card point of seven
6. A two card or three card point of six
7. A two card or three card point of five
8. A two card or three card point of four
9. A two card or three card point of three
10. A two card or three card point of two
11. A two card or three card point of one
12. 'Baccarat' (zero)

6.26 If the two hands are of equal merit, the wagers on punter and banker shall be void and the wagers on 'Egalité' shall win and be paid, at a minimum, odds of **8 to 1**.

6.27 Cards will be drawn strictly in accordance the Table of Play shown below.

		Punter given											
		0	1	2	3	4	5	6	7	8	9	No card	
Banker's point	3	D	D	D	D	D	D	D	D	S	D	D	
	4	S	S	D	D	D	D	D	D	S	S	D	
	5	S	S	S	S	D	D	D	D	S	S	D	
	6	S	S	S	S	S	S	D	D	S	S	S	
D = Draw						S = Stand							
Banker: 0, 1 or 2 - draws 3, 4, 5 or 6 - (see above) 7 - stands 8 or 9 - no further draw						Punter: 0, 1, 2, 3, 4 or 5 - draws 6 or 7 - stands 8 or 9 - no further draw							

Permitted variations to Punto Banco

Punto Banco 2000

6.28 The variation to the game known as Punto 2000 is played exactly as the standard game of Punto Banco, as detailed in this section, except that the minimum payment odds for any winning wagers on the banker (as given in rule 6.18) will not apply.

- 6.29 Instead, winning wagers on the banker shall be paid at a minimum, odds of **1 to 1**, other than circumstances where the banker wins with a card total of 6. In that case, the winning wager shall be paid at a minimum, odds of **1 to 2**.
- 6.30 Wagers may not be accepted for Punto 2000 during a game for which wagers on the standard game of Punto Banco, referred to in this document, are also accepted.

'Dragon Bonus' side wager

- 6.31 It is at the discretion of the licence holder whether or not to offer the 'Dragon Bonus' side wager as an additional, optional wager in the standard game of Punto Banco or Punto Banco 2000. The proprietor of the side wager is Shufflemaster Inc and no variations may be put forward without their prior agreement.
- 6.32 The feature shall only be available at a table or tables marked for the provision of the wager, hereafter called the 'Dragon Bonus' side wager.
- 6.33 Players do not need to place a standard wager on either the player, the banker or Egalite, in order to place a Dragon Bonus side wager.
- 6.34 Players may wager any amount within the table limits as their Dragon Bonus side wager, which must be wagered before any cards are dealt.
- 6.35 The player may place a Dragon Bonus side wager on either the player's hand or the dealer's hand, hereafter referred to as the 'selected hand', but not on both. To do so, they will place the wager in one of the dedicated betting positions in front of them, either alongside the player wager or the banker wager respectively.
- 6.36 After all standard wagers and Dragon Bonus wagers have been placed, a standard game of Punto Banco or Punto 2000 will take place, in accordance with the procedures in this section.
- 6.37 The dealer will reconcile the player's standard wager, where applicable, before dealing with any Dragon Bonus side wager on that playing position.
- 6.38 Players have two ways to win the Dragon Bonus side wager depending on whether the selected hand is a 'natural' winner (being a score of eight or nine with the first two cards dealt to that hand) or a 'non-natural' winner (being the winning score after a third card has been dealt to that hand) in accordance with the Table of Play given in rule 6.27.
- 6.39 If their selected hand is a natural winner, the Dragon Bonus side wager will win and be paid, as a minimum, odds of **1 to 1 (even money)**.
- 6.40 If the selected hand is a natural winner, but ties, then the Dragon Bonus side wager will be a stand off and the wager will be returned to the player.

6.41 If the selected hand for the Dragon Bonus wager is a ‘non-natural’ winning score, and wins by four clear points, the Dragon Bonus side wager will win and be paid, as a minimum, at the following odds:

Winning margin of non-natural winner	Minimum odds payable
Win by 9 points	20-1
Win by 8 points	8-1
Win by 7 points	4-1
Win by 6 points	4-1
Win by 5 points	2-1
Win by 4 points	1-1

Please note that the above table shows the minimum permitted odds that may be paid, drawn from the pay tables given in section 6.42. However, the full list of minimum odds is not, in itself, a well-balanced pay table and in fact carries a house edge of between 11.2% and 16.7%, depending on whether six or eight decks are used. It is therefore recommended that they are only used as a guide and not as a pay table in themselves.

6.42 In addition to offering, as a minimum, the odds given in rule 6.41 above, odds for non-natural winners may be presented as complete pay tables, in accordance with rule 2.9 given in section 2. Permitted pay tables are as follows:

Pay table 1

Win by 9 points	30-1
Win by 8 points	10-1
Win by 7 points	6-1
Win by 6 points	4-1
Win by 5 points	2-1
Win by 4 points	1-1

Pay table 2

Win by 9 points	20-1
Win by 8 points	8-1
Win by 7 points	7-1
Win by 6 points	4-1
Win by 5 points	3-1
Win by 4 points	1-1

Pay table 3

Win by 9 points	30-1
Win by 8 points	10-1
Win by 6-7 points	4-1
Win by 4-5 points	2-1

- 6.43** If the selected hand is a non-natural winner, with a score, but does not win by a clear four points, the Dragon Bonus side wager will lose and be surrendered to the house.
- 6.44** If the selected hand does not win, the Dragon Bonus side wager will lose and will be surrendered to the house.

7. Casino Stud Poker

The table layout

- 7.1 Figure 9 shows an example of the style of game layouts that may be offered to players. It also illustrates the full range of wagers available, including the optional Progressive and Bonus Insurance wagers, and the position at which such wagers must be placed on the layout.

Figure 9

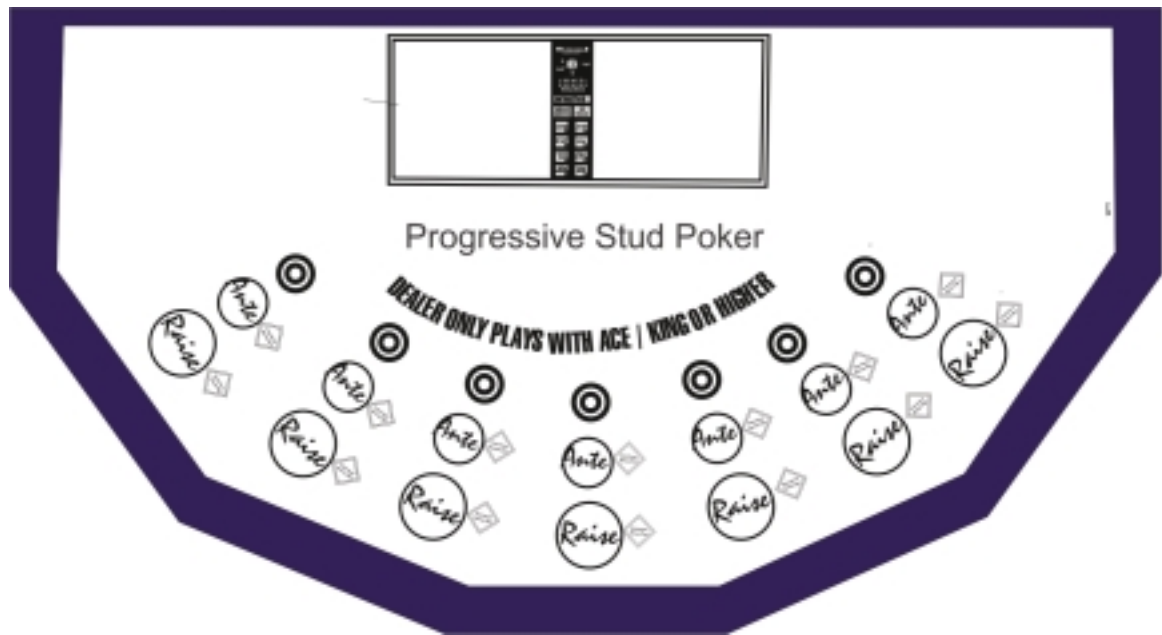

- 7.2 Other than the Progressive wager detailed in rules 7.16 to 7.21, only side wagers or variations listed in rules 7.22 and onwards of this section are permitted, unless agreed with the Commission in accordance with the rules detailed in section 2.3 and 2.4.

General rules

- 7.3 Casino Stud Poker shall be played with a single pack of 52 cards.
- 7.4 Operators must have procedures in place to ensure the security and integrity of the cards.
- 7.5 The maximum and minimum wagers permitted shall be shown on a notice prominently displayed at the table. Partnerships with a view to exceeding the maximum stake shall not be permitted.
- 7.6 The relative value of each of the cards is as follows (in descending order): Ace, King, Queen, Jack, 10, 9, 8, 7, 6, 5, 4, 3, and 2, except that the Ace may be used as a value of one in order to complete a Straight Flush or a Straight, as defined in rule 6.7 below (being 3, 2, Ace).

7.7 The terms used to describe the five cards held by a participant in the game of Casino Stud Poker shall be in accordance with the following meanings and hand rankings:

- a) **Royal Flush** – Ace, King, Queen, Jack and 10 of the same suit
- b) **Straight Flush** – five cards of consecutive values of the same suit
- c) **Four of a Kind** – four cards of the same value
- d) **Full House** – three cards of the same value together with two cards of the same value being different to the first value
- e) **Flush** – five cards of the same suit
- f) **Straight** – five cards of consecutive values not being a Royal Flush or a Straight Flush
- g) **Three of a Kind** – three cards of the same value
- h) **Two pairs** – two cards of the same value together with two cards of the same value being different to the first value
- i) **One pair** – two cards of the same value
- j) **No pair** – the highest value cards of the hand

Initial wager

7.8 Only one wager may be accepted on each playing position, and no individual player may place a wager on more than one playing position.

7.9 Any initial wager will be made by an opposing player against the dealer. The initial wager, hereafter referred to as the Ante, shall be made before any cards are dealt in the game, and shall be placed in the designated betting area.

7.10 Each opposing player and the dealer shall be dealt five cards, starting from the player to the dealer's left. All cards will be dealt face down with the exception of the dealer's fifth card, which shall be dealt face up.

7.11 It is the player's own responsibility to establish the value of their hand.

7.12 After looking at their cards, players who wish to continue in the game shall then make a second wager called the 'Raise' which must be exactly twice the original Ante wager. Those players not making the additional wager will surrender the amount staked on the Ante to the bank.

7.13 The remaining wagers will win if, on revealing the dealer's hand:

- a) The dealer does not have a hand containing Ace/King or better, in which case the hand will be complete and the Ante wager will only win, at a minimum, odds of **1 to 1**; and
- b) The dealer does have a hand containing Ace/King or better and the player has a hand which outranks it. The player's Ante wager will win, at a minimum, odds of **1 to 1**, and the Raise wager will win and be paid in accordance with the following minimum odds

- i) **Straight Flush** – minimum odds payable **50 to 1**
- ii) **Four of a Kind** – minimum odds payable **20 to 1**
- iii) **Full House** – minimum odds payable **8 to 1**
- iv) **Flush** – minimum odds payable **6 to 1**
- v) **Straight** – minimum odds payable **4 to 1**
- vi) **Three of a Kind** – minimum odds payable **3 to 1**
- vii) **Two pairs** – minimum odds payable **2 to 1**
- viii) **One pair or less** – minimum odds payable **1 to 1**

A sign or notice will be displayed at the table showing the bonus odds payable for the above hands.

7.14 A player's hand that is outranked by the dealer's hand will lose both their Ante and Raise wagers.

7.15 Wagers will be void if the player's hand is of exactly equal ranking to the dealer's hand.

Progressive wager

7.16 At the licence holder's discretion, a casino may introduce an additional feature into the game, namely a Progressive Jackpot wager. The general rules detailed in 2.7 of section 2 will apply.

7.17 A Progressive Jackpot wager shall be an optional wager that an opposing player may place at the same time as he places an Ante wager.

7.18 A Progressive Jackpot wager may not be placed unless an Ante wager has also been placed at the same time.

7.19 A Progressive Jackpot wager shall be placed in a designated slot, spot or dedicated area, set into or otherwise made available at each playing position.

7.20 A Progressive wager is a wager that the player will receive one of a specific set of hands, as per rule 7.21. If such a hand is dealt, the player will win regardless of whether the hand also beat the dealer, or whether the dealer receives Ace/King or better.

7.21 If upon the hand being revealed, an opposing player who has placed a Progressive Jackpot wager has a hand containing one of the following rankings, the player's Progressive Jackpot wager shall win, and be paid from the Progressive Jackpot Meter, the following minimum amounts:

- a) **Royal Flush (100% of the Progressive Jackpot Meter)**
- b) **Straight Flush (10% of the Progressive Jackpot Meter)**
- c) **Four of a Kind (100 times the value of the wager)**
- d) **Full House (75 times the value of the wager)**
- e) **Flush (50 times the value of the wager)**

Permitted variations to Casino Stud Poker

Casino stud bonus insurance

- 7.22** It is at the discretion of the licence holder whether or not to offer Casino Stud Bonus Insurance (CSBI) as an additional, optional feature in the standard game of Casino Stud Poker. The proprietor of the CSBI side feature is Prime Table Games and no variations may be put forward without their prior agreement.
- 7.23** The feature shall only be available at a table or tables marked for the provision of the CSBI wagers, hereafter called the Insurance wager and Double wager.
- 7.24** A player may not place an Insurance wager unless they have also placed a standard initial Ante wager.
- 7.25** Players may wager any amount within the table limits as their Insurance wager, which must be wagered before any cards are dealt.
- 7.26** The dealer will conduct the initial deal and reveal the final card dealt to their own five-card hand, face up, in accordance with rule 7.10. This card is hereafter referred to as the 'dealer's up card'.
- 7.27** If the dealer's up card has a value of **two, three, four or five**, any player with an Insurance wager is then offered the opportunity to 'double'. They may then place a Double wager of an equal amount to their Insurance wager. If they do not wish to place a Double wager, the player may decline the opportunity and elect to stay with the original Insurance wager.
- 7.28** If the dealer's up card has a value **other than** two, three, four or five, all Insurance wagers will remain in place without the option to double.
- 7.29** Once all players have made their decisions to raise or fold and, where applicable, place a Double wager (in accordance with rules 7.27 and 7.28) the dealer will address the Ante wagers from each player who has elected to fold.
- 7.30** If a player who has elected to fold **does not** have any CSBI wagers (Insurance or Double), their Ante wager will lose and be surrendered to the bank. Their cards will then be collected by the dealer.
- 7.31** If a player who has elected to fold **does** have any CSBI wagers, their Ante wager will lose and be surrendered to the bank, **but their CSBI wager(s) and folded hand will remain in action**. The dealer must cover the player's Ante betting position with their cards face down to indicate that their CSBI wager(s) remain in action.

Dealer's qualifying hand

- 7.32** If the dealer has a qualifying hand of Ace/King or better at the end of the game, standard Ante and Raise wagers will be settled in accordance with rule 7.13(b), but all CSBI wagers will lose and be surrendered to the bank.

Dealer's non-qualifying hand

7.33 If the dealer **does not** have a qualifying hand of Ace/King or better at the end of the game, standard Ante and Raise wagers will be settled in accordance with rule 7.13(a). However, the player's Insurance wager and, where applicable, Double wager, will be paid according to the following minimum odds:

Royal Flush	100-1
Straight Flush	50-1
Four of a Kind	20-1
Full House	8-1
Flush	6-1

7.34 If a player has a hand with a ranking of a **Flush or higher**, in accordance with the card rankings given in rule 7.7, the minimum odds paid out to the Insurance wager and Double wager, where applicable, will be based on the value of the **player's own hand** ranking.

7.35 If the player has a hand ranking of **less than a Flush**, the minimum odds paid out to the Insurance wager and Double wager will be based on the value of the **dealer's** hand ranking in accordance with the following minimum odds:

Dealer hand	Player with less than a Flush paid:
7 High	5-1
8 High	4-1
9 or 10 High	2-1
Less than an Ace/King	1-1 (even money)

The player will only be paid one set of odds. For example, if the player has Four of a Kind and the dealer has 9-High, the player will be paid 20-1. However, they will not be paid both.

8. Dice/Craps

The table layout

- 8.1 Figure 10 shows an example of the style of game layout that may be offered to players. It also illustrates the full range of bets available.

Figure 10



- 8.2 Only variations listed in rules 8.20 and onwards in this section are permitted, unless agreed by the Commission, in accordance with the rules detailed in section 2.3 and 2.4.

General rules

- 8.3 Two dice shall be thrown at every throw made in the course of the game. The side of each of the dice shall be marked with values from 1 to 6, so arranged that the sum of the values of any pair of opposite sides total seven.
- 8.4 Operators must have procedures in place to ensure the security and integrity of the dice.
- 8.5 In these rules, the term 'Stickman' and/or 'Boxman' refer to people operating and controlling the game on behalf of the licence holder.
- 8.6 The maximum and minimum wagers permitted shall be shown on a notice prominently displayed at the table. Partnerships with a view to exceeding the maximum stakes shall not be permitted.
- 8.7 Wagers orally declared shall be accepted only if accompanied by the placing of sufficient chips or cash on the table to cover the wager and verbally confirmed by the Boxman or Stickman.
- 8.8 The dice shall be thrown by one of the players termed the 'Shooter'. To determine who shall be the Shooter at the commencement of play, the Stickman will offer the dice to the player immediately to the left of the Boxman. If that player does not accept, or otherwise on miniature versions of the game, the dice will be offered to each player in turn, clockwise around the table.

- 8.9** When a Shooter relinquishes the dice in the course of play, the dice will pass to the player immediately to the left of the previous Shooter and, if he does not accept, again to each of the players in turn clockwise around the table.
- 8.10** The Shooter must maintain a wager on the 'Win Line' or the 'Don't Win Line' (see rule 8.17).
- 8.11** The Shooter shall throw the two dice so that they leave his hand simultaneously, with a view to striking the end of the table furthest from him.
- 8.12** Any wager in relation to the game shall be of a kind specified in rule 8.17 and shall be payable if won and at the appropriate odds there specified.
- 8.13** The following terms shall have the following meanings in these rules:
- a) **'Point'** The sum of the two numbers shown on the uppermost faces of the two dice.
 - b) **'Come Out Point'** A point of 4, 5, 6, 8, 9, or 10 thrown by the Shooter on his Come Out Roll and which, if thrown by him again before a total of 7 on his subsequent throw or throws, shall constitute a win for wagers on the Win Line (see rule 8.17).
 - c) **'Loser 7'** A point of 7 thrown by the Shooter subsequent to his establishment of a Come Out Point.
- 8.14** The Shooter shall relinquish the dice if he throws a Loser 7 (see rule 8.13(c)).
- 8.15** If the Shooter throws a Come Out Point, he shall subject to rule 8.14, remain as the Shooter until he repeats that point on a subsequent throw.
- 8.16** Subject to rules 8.14 and 8.15, or at the instruction of the Boxman, the Shooter will have the option after any throw either to pass the dice or to remain the Shooter for the subsequent throw.

Wagers and odds

- 8.17** The results of wagers made, and the minimum odds that may be paid, are as follows:

	Wagers on:	Shall:
a.	Win (or Pass) Line - placed on the Shooter's first throw (the Come Out Roll) - at minimum odds of 1 to 1	Win if 7 or 11 is thrown Lose if 2, 3 or 12 is thrown Remain Unchanged if any number other than these five is thrown, in which case that number, termed the Come Out Point is established and these wagers subsequently: Win if the Come Out Point is thrown before a 7

		<p>Lose if a 7 is thrown before the Come Out Point</p> <p>*See note at the end</p>
b.	<p>Don't Win Line (Don't Pass Line)</p> <ul style="list-style-type: none"> - placed on the Shooter's first throw (the Come Out Roll) - at minimum odds of 1 to 1 	<p>Win if the 3 or 12 is thrown</p> <p>Lose if 7 or 11 is thrown</p> <p>Be Void if a 2 is thrown</p> <p>Remained Unchanged if a Come Out Point is established in which case these wagers subsequently:</p> <p>Win if a 7 is thrown before the Come Out Point</p> <p>Lose if the Come Out Point is thrown again before a 7</p>
c.	<p>Come</p> <ul style="list-style-type: none"> - placed at any time after the Shooter's Come Out Roll - at minimum odds of 1 to 1 	<p>Win, Lose or Remain Unchanged in accordance with rule 8.17(a) above</p> <p>*See note at the end</p>
d.	<p>Don't Come</p> <ul style="list-style-type: none"> - placed at any time after the Shooter's Come Out Roll - at minimum odds of 1 to 1 	<p>Win, Lose, Be Void or Remain Unchanged in accordance with rule 8.17(b) above</p>
e.	<p>Behind the Win Line</p> <ul style="list-style-type: none"> - placed, after the establishment of a Come Out Point, by a player who already has a wager of the same amount or larger on the Win Line - at odds depending on the point as follows: <p>4 or 10 at minimum odds of 2 to 1 5 or 9 at minimum odds of 3 to 2 6 or 8 at minimum odds of 6 to 5</p>	<p>Win if the Come Out point is thrown again before a 7</p> <p>Lose if a 7 is thrown before the Come Out Point</p> <p>Remain Unchanged if any other point is thrown and become subject to the result of the subsequent throw</p>

f.	<p>Behind the Don't Win Line (Don't Win Lay Bets) - placed by a player, after the establishment of a Come Out Point to win not more than the amount already being wagered against as follows:-</p> <p>4 or 10 at minimum odds of 1 to 2 5 or 9 at minimum odds of 2 to 3 6 or 8 at minimum odds of 5 to 6</p>	<p>Win if a 7 is thrown before the Come Out point is thrown again</p> <p>Lose if the Come Out Point is thrown before a 7</p> <p>Remain Unchanged if any other point is thrown and become subject to the result of the subsequent throw</p>
g.	<p>Behind the Come - placed by a player who has a wager of the same amount or larger on the Come</p> <p>- at odds as in 8.20(e)</p>	<p>Win, Lose, Remain Unchanged in accordance with rule 8.17(e) above except that these wagers are not valid on any Come Out Roll unless previously called 'On' (ie orally declared to be in play by the player)</p>
h.	<p>Behind the Don't Come (Don't Come Lay Bets) - placed by a player to win not more than the amount already being wagered by him on Don't Come</p> <p>- at odds as in rule 8.20(f)</p>	<p>Win, Lose, Remain Unchanged in accordance with rule 8.17(f)</p> <p>These wagers shall remain in action on any Come Out Roll unless previously called 'Off' by the player</p>
i.	<p>Hardways - placed by a player to wager that both dice will show the same number (a double) in one of the following combinations: Two 2s at minimum odds of 7½ to 1 Two 3s at minimum odds of 9½ to 1 Two 4s at minimum odds of 9½ to 1 Two 5s at minimum odds of 7½ to 1</p>	<p>Win if the exact combination nominated is thrown before any other combination producing the same point or 7</p> <p>Lose if any other combination producing the same point or 7 is thrown before the exact combination nominated</p> <p>Remain Unchanged if any other point is thrown, and becomes subject to the result of the next throw</p>

j.	<p>Place Bets (Box Numbers) to Win - at minimum odds depending on the point as follows: 6 or 8 at minimum odds of 7 to 6 5 or 9 at minimum odds of 7 to 5 4 or 10 at minimum odds of 9½ to 5</p>	<p>Win if the Box Number is thrown before a 7</p> <p>Lose if 7 is thrown before the Box Number</p> <p>Remain Unchanged if any other point is thrown and becomes subject to the result of the subsequent throw</p> <p>Except that these wagers shall not be valid on any Come Out Roll unless previously called 'On' (ie orally declared to be in play by the player)</p>
k.	<p>Place Bets (Box Numbers) to Lose (Don't Lay Bets) - at minimum odds depending on the point wagered against as follows: 6 or 8 at minimum odds of 4 to 5 5 or 9 at minimum odds of 5 to 8 4 or 10 at minimum odds of 5 to 11</p>	<p>Win if 7 is thrown before the Box Number</p> <p>Lose if the Box Number is thrown before a 7</p> <p>Remain Unchanged if any other point is thrown and becomes subject to the result of the subsequent throw</p> <p>These wagers shall remain in action on any Come Out Roll unless previously called 'Off' by the player</p>
l.	<p>Any Craps - at minimum odds of 7½ to 1</p>	<p>Win if 2, 3, or 12 is thrown</p> <p>Lose if any other point is thrown</p>
m.	<p>Craps 2 - at minimum odds of 33 to 1</p>	<p>Win if two 1s are thrown</p> <p>Lose if any other point is thrown</p>
n.	<p>Craps 3 - at minimum odds of 16 to 1</p>	<p>Win if 3 is thrown</p> <p>Lose if any other point is thrown</p>
o.	<p>Craps 12 - at minimum odds of 33 to 1</p>	<p>Win if 12 is thrown</p> <p>Lose if any other point is thrown</p>

p.	Eleven - at minimum odds of 16 to 1	Win if 11 is thrown Lose if any other point is thrown
q.	Any Seven - at minimum odds of 4 to 1	Win if 7 is thrown Lose if any other point is thrown
r.	A Specific Pair Combination - at minimum odds of 33 to 1	Win if specific pair is thrown (1,1)(2,2) etc Lose if any other combination is thrown
s.	A Specific Non-Pair Combination - at odds of 16 to 1	Win if specific non-pair is thrown (1,3) (2,4), etc Lose if any other combination is thrown
t.	Field - at minimum odds depending on the point as follows: 3, 4, 9, 10 or 11 at 1 to 1 2 at 2 to 1 12 at 3 to 1	Win if 2, 3, 4 ,9 ,10, 11 or 12 is thrown Lose if 5, 6, 7 or 8 is thrown

* No stake wagered under 8.17(a) or 8.17(c) above shall be removed or reduced after the establishment of the respective Come Out or Come Point until that wager is either won or lost.

8.18 It is not a requirement that all bets are made available on any particular table. However, no variation may be considered in addition to the bets and minimum odds given in rule 8.17 above, other than in accordance with the rules detailed in section 2.3 and 2.4, or listed in rule 8.20.

8.19 Where any odds offered are higher than the minimum odds, the details of any change should be made clearly available to players on the table(s) concerned.

Permitted variations to dice/craps

8.20 Any permitted variations to the existing game will be listed here. There are none at present.

9. Sic Bo

The table layout

9.1 Figures 11 and 12 show examples of the style of game layout that may be offered to players. They also illustrate the full range of bets available.

Figure 11: Example of 50 position layout

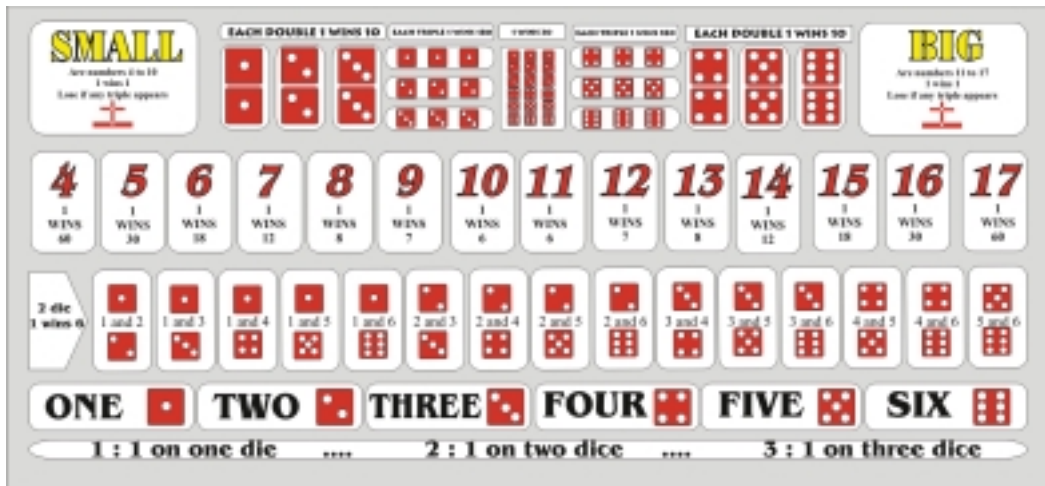
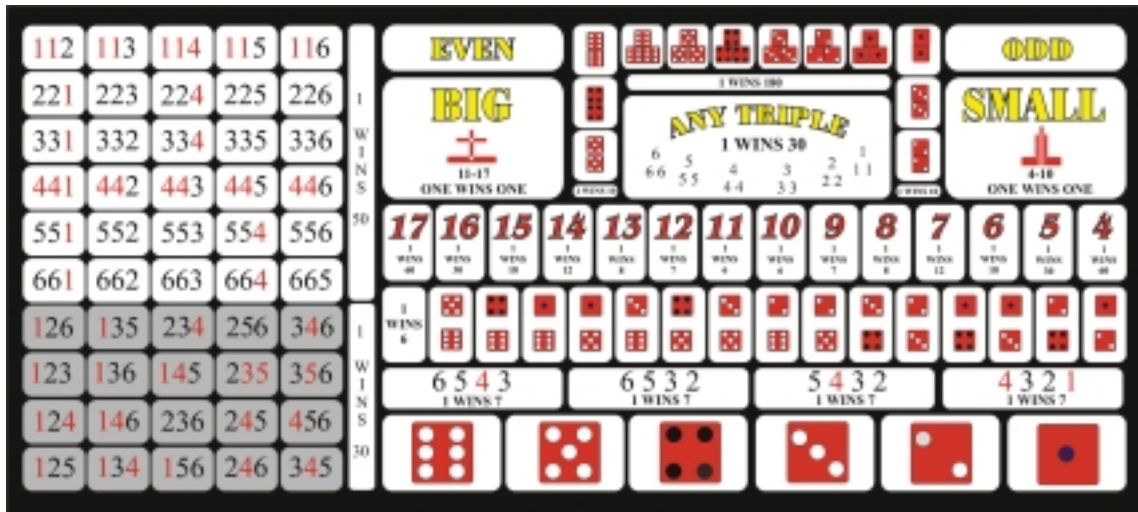

Figure 12: Example of 106 position layout



9.2 Only variations listed in rules 9.13 and onwards in this section are permitted, unless agreed by the Commission in accordance with the rules detailed in section 2.3 and 2.4.

General rules

9.3 Three dice shall be thrown at every throw made in the course of the game. The side of each of the dice shall be marked with values from 1 to 6, so arranged that the sum of the values of any pair of opposite sides total seven.

- 9.4 Operators must have procedures in place to ensure the security and integrity of the dice.
- 9.5 The maximum and minimum wagers permitted shall be shown on a notice prominently displayed at the table. Partnerships with a view to exceeding the maximum stakes shall not be permitted.
- 9.6 Wagers orally declared shall be accepted only if accompanied by the placing of sufficient chips or cash on the table to cover the wager and verbally confirmed by the dealer.
- 9.7 A dice shaker/tumbler device, either manually or electrically operated, shall be used to tumble the dice.
- 9.8 The table shall be fitted with electrical equipment to illuminate the winning areas of the layout. The entry of a declared result of the game, by activation of the relevant numbered buttons on the control panel, shall cause all the winning areas of the layout to be illuminated.
- 9.9 Electrical devices and equipment used to operate the game of Sic Bo must conform to the technical standards as outlined in the Commission's publication entitled *Bingo and Casino Equipment Technical Requirements*, published in June 2007.
- 9.10 Any wager in relation to the game shall be of a kind specified in rule 9.12 below, and shall be payable, if won, at the appropriate minimum odds there specified.
- 9.11 Each player shall be responsible for the positioning of his wager or wagers on the table, whether or not he is assisted by the dealer. The player must ensure that any instructions that he gives are correctly carried out. Wagers shall be settled strictly in accordance with the position of the chips on the layout at the time that the dice shaker is uncovered.

Wagers and odds

- 9.12 The available bets, and minimum odds payable are shown below. In this schedule, a 'Double' means two dice showing the same score and a 'Triple' means three dice showing the same score. Where any odds offered are higher than the minimum odds shown in this schedule, the details of any change should be made clearly available to players on the table or tables concerned:
- Small:** a wager that the total score on the next throw of the dice will be 4, 5, 6, 7, 8, 9 or 10 in any combination with the exception of a triple. The minimum odds payable if the wager is won shall be **1 to 1**.
 - Big:** a wager that the total score on the next throw of the dice will be 11, 12, 13, 14, 15, 16 or 17 in any combination with the exception of a triple. The minimum odds payable if the wager is won shall be **1 to 1**.
 - Odd:** a wager that the total score on the next throw of the dice will be 5, 7, 9, 11, 13, 15 or 17 in any combination with the exception of a triple. The minimum odds payable if the wager is won shall be **1 to 1**.

- d) **Even:** a wager that the total score on the next throw of the dice will be 4, 6, 8, 10, 12, 14 or 16 in any combination with the exception of a triple. The minimum odds payable if the wager is won shall be **1 to 1**.
- e) **Specific Triples:** a wager that on the next throw of the dice a specific triple will appear. The minimum odds payable if the wager is won shall be **180 to 1**.
- f) **Specific Doubles:** a wager that on the next throw of the dice a specific double will appear. The minimum odds payable if the wager is won shall be **10 to 1**.
- g) **Any Triple:** a wager that on the next throw of the dice any of the triples will appear. The minimum odds payable if the wager is won shall be **30 to 1**.
- h) **Three Dice Total:** a wager that on the next throw of the dice a specific total score of 4, 5, 6, 7, 8, 9, 10, 11, 12, 13, 14, 15, 16 or 17 will appear. The minimum odds payable if the wager is won shall be, where the score wagered on is:
 - i) 4 or 17, minimum odds payable **60 to 1**
 - ii) 5 or 16, minimum odds payable **30 to 1**
 - iii) 6 or 15, minimum odds payable **18 to 1**
 - iv) 7 or 14, minimum odds payable **12 to 1**
 - v) 8 or 13, minimum odds payable **8 to 1**
 - vi) 9 or 12, minimum odds payable **7 to 1**
 - vii) 10 or 11, minimum odds payable **6 to 1**

- i) **Dice Combinations:** a wager that on the next throw of the dice two of the three dice will show one of the following specific combinations, that is to say:
 - i) the number 1 together with the specific number 2, 3, 4, 5 or 6
 - ii) the number 2 together with the specific number 3, 4, 5 or 6
 - iii) the number 3 together with the specific number 4, 5 or 6
 - iv) the number 4 together with the specific number 5 or 6
 - v) the number 5 together with the number 6

The minimum odds payable if the wager is won shall be **6 to 1**.

- j) **Single Dice Bet:** a wager that on the next throw of the dice the specific number 1, 2, 3, 4, 5 or 6 will appear. The minimum odds payable if the wager is won shall be, if the number wagered on appears:
 - i) on one of the dice, **1 to 1**
 - ii) on two of the dice, **2 to 1**
 - iii) on three of the dice, **3 to 1**
- k) **Four Number Combination:** a wager that on the next throw of the dice any three of the four numbers in one of the following specific combinations will appear:
 - i) the numbers 6, 5, 4, 3
 - ii) the numbers 6, 5, 3, 2
 - iii) the numbers 5, 4, 3, 2
 - iv) the numbers 4, 3, 2, 1

The minimum odds payable if the wager is won shall be **7 to 1**.

l) **Three Single Number Combination:** a wager that on the next throw of the dice one of the following specific combinations will appear:

- i) the numbers 1, 2, 6
- ii) the numbers 1, 3, 5
- iii) the numbers 2, 3, 4
- iv) the numbers 2, 5, 6
- v) the numbers 3, 4, 6
- vi) the numbers 1, 2, 3
- vii) the numbers 1, 3, 6
- viii) the numbers 1, 4, 5
- ix) the numbers 2, 3, 5
- x) the numbers 3, 5, 6
- xi) the numbers 1, 2, 4
- xii) the numbers 1, 4, 6
- xiii) the numbers 2, 3, 6
- xiv) the numbers 2, 4, 5
- xv) the numbers 4, 5, 6
- xvi) the numbers 1, 2, 5
- xvii) the numbers 1, 3, 4
- xviii) the numbers 1, 5, 6
- xix) the numbers 2, 4, 6
- xx) the numbers 3, 4, 5

The minimum odds payable if the wager is won shall be **30 to 1**.

m) **Specific Double and Single Number Combination:** a wager that on the next throw of the dice two of the three dice will show a specific double and the third dice will show a specific single number other than that on the other two dice.

The minimum odds payable if the wager is won shall be **50 to 1**.

Permitted variations to Sic Bo

9.13 Any permitted variations to the existing game will be listed here. There are none at present.

10.2 'Big Six' (or any other name used to portray the same game, such as Wheel of Fortune, Big Wheel etc) will be played with a circular wheel which shall have 52 equal compartments marked with seven different symbols. The numbers or designs used as symbols may be of any theme chosen by the operator. However, symbols or designs must be allocated to the 52 compartments (segments) in the order shown in Figure 13. The number of compartments allocated to each symbol will be as follows:

Symbol	Number of compartments
Type A	1
Type B	1
Type C	2
Type D	4
Type E	8
Type F	12
Type G	24

10.3 The wheel shall have a selector device (clapper) attached to the top, which is able to come to rest in the segment that lands at random immediately beneath it once the wheel has stopped spinning.

10.4 Only variations listed in rules 10.11 and onwards in this section are permitted, unless agreed by the Commission, in accordance with the rules detailed in section 2.3 and 2.4.

General rules

10.5 Operators must have procedures in place to ensure the security and integrity of the wheel.

10.6 The maximum and minimum wagers permitted shall be shown on a notice prominently displayed at the table. Partnerships with a view to exceeding the maximum stakes shall not be permitted.

10.7 Wagers orally declared shall be accepted only if accompanied by the placing of sufficient chips or cash on the table to cover the wager and verbally confirmed by the dealer.

10.8 Each player shall be responsible for the positioning of their wager or wagers on the table, whether or not they are assisted by the dealer. The player must ensure that any instructions they give are correctly carried out. Wagers shall be settled strictly in accordance with the position of the chips on the layout at the time that the wheel comes to rest.

10.9 Any wager in relation to the game shall be a wager as to which segment of the wheel the clapper will settle in when the wheel stops, and shall be payable, if won, at the following minimum odds:

Symbol type	Minimum odds
Type A	50-1
Type B	50-1
Type C	20-1
Type D	10-1
Type E	5-1
Type F	3-1
Type G	1-1

- 10.10** If the clapper comes to rest between two segments, the casino licence holder has the option to do one of the following:
- a) declare the winning number to be the number previously passed; or
 - b) declare the spin void and re-spin the wheel.

Whichever option a licence holder chooses from a) and b) above, a sign or notice shall be clearly displayed so that players are aware of this.

Permitted variations to Big Six

- 10.11** Any permitted variations to the existing game will be listed here. There are none at present.

11. TEXAS HOLD 'EM POKER

The table layouts

11.1 There are four casino variations of Texas Hold 'Em Poker approved by these rules. Each is a proprietary game licensed in the UK by the registered owner. Figures 18 to 21 show example layout designs for each variation.

Figure 18: WSOP Texas Hold 'Em Bonus Poker Copyright PGI

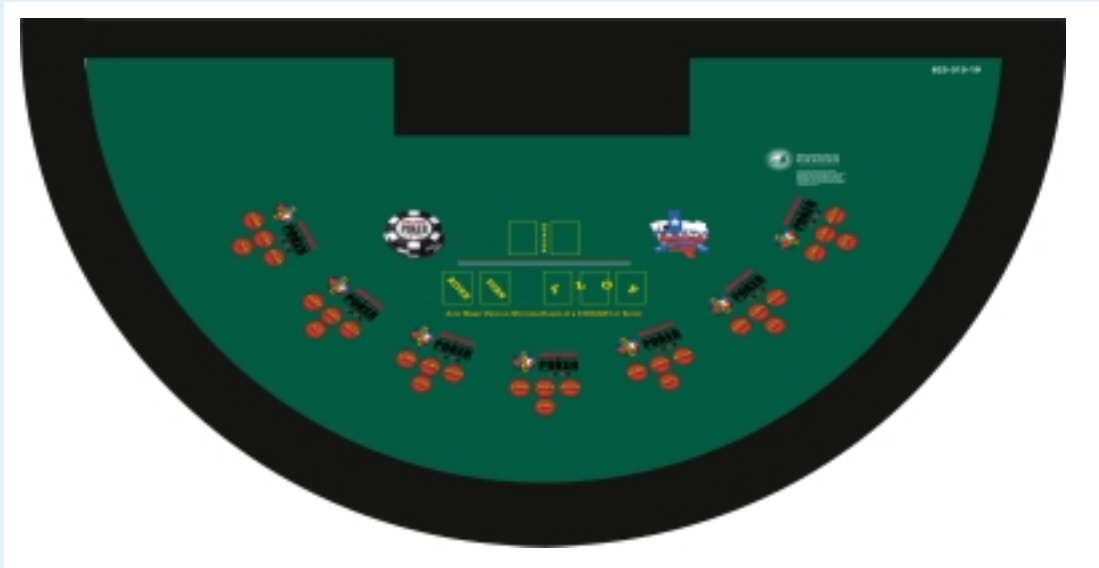

Figure 19: Ultimate Texas Hold 'Em Poker Copyright Shufflemaster



Figure 20: Casino Hold 'Em Poker Copyright TCSJohnHuxley

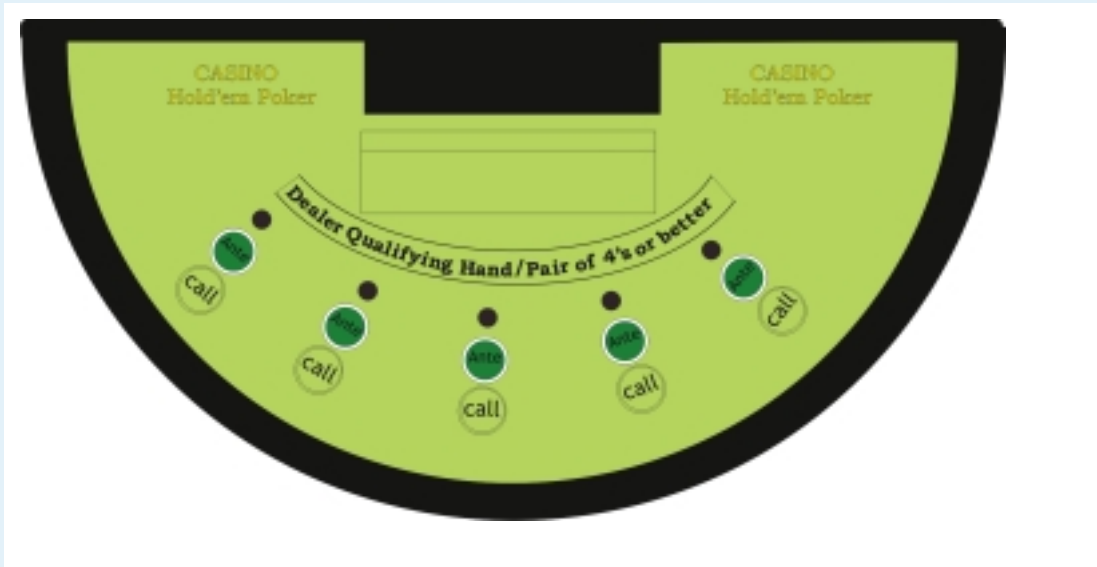
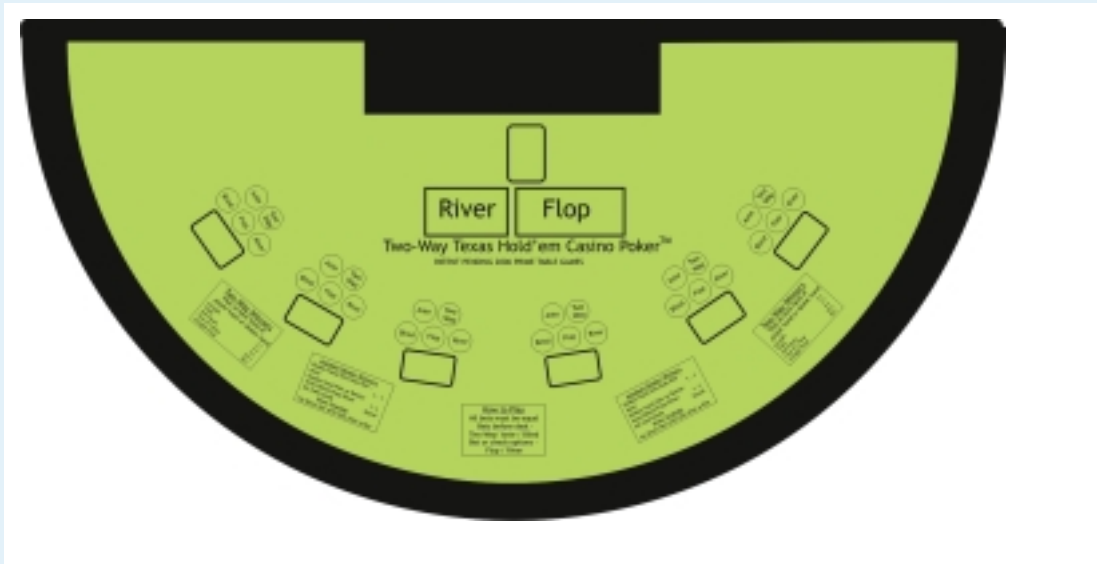

Figure 21: Two Way Poker Copyright Prime Table Games



General rules

- 11.2 Only the variations and side wagers listed in this section are permitted, unless agreed by the proprietors and then approved by the Commission in accordance with the rules detailed in section 2.3 and 2.4.
- 11.3 All versions of Texas Hold 'Em shall be played with a single pack of 52 cards.
- 11.4 Operators must have procedures in place to ensure the security and integrity of the cards.
- 11.5 The maximum and minimum wagers permitted shall be shown on a notice prominently displayed at the table. Partnerships with a view to exceeding the maximum stake shall not be permitted.

- 11.6** The relative value of each of the cards is as follows (in descending order): Ace, King, Queen, Jack, 10, 9, 8, 7, 6, 5, 4, 3, and 2, except that the Ace may be used as a value of one in order to complete a Straight Flush or a Straight, as defined in rule 11.7 below (being 5, 4, 3, 2, and Ace).
- 11.7** The terms used to describe the five-card hands, and descending order of hand rankings, in all approved versions of Texas Hold 'Em Poker shall be in accordance with the following:
- a) **Royal Flush** – Ace, King, Queen, Jack and 10 of the same suit;
 - b) **Straight Flush** – five cards of consecutive values of the same suit;
 - c) **Four of a Kind** – four cards of the same value;
 - d) **Full House** – three cards of the same value together with two cards of the same value being different to the first value;
 - e) **Flush** – five cards of the same suit;
 - f) **Straight** – five cards of consecutive values not being a Royal Flush or a Straight Flush;
 - g) **Three of a Kind** – three cards of the same value;
 - h) **Two pairs** – two cards of the same value together with two cards of the same value being different to the first value;
 - i) **One pair** – two cards of the same value;
 - j) **High Card/No pair** – the highest value cards of the hand.
- 11.8** The terminology used to describe the cards dealt within all versions of Texas Hold 'Em Poker is as follows:
- a) **'Hole Cards'** The two cards dealt to the player and dealer;
 - b) **'The Flop'** The first three communal cards dealt;
 - c) **'The Turn'** The fourth communal card dealt;
 - d) **'The River'** The fifth and final communal card dealt.
 - e) **'Playing the Board'** Where the best poker hand for one or more players and/or the dealer is actually to use all five communal cards, and neither of the player/dealer's two hole cards.
 - f) **'Fold'** A player electing to throw in their hand and surrender their wagers to the house.
- 11.9** In all versions of the game detailed in this section, only one player may wager on each playing position, and no individual player may place a wager on more than one playing position.
- 11.10** In all versions of Texas Hold 'Em approved within this section, each participating player and the dealer will be dealt an initial hand of two cards (the hole cards), face downwards. Cards are always dealt starting from the player on the dealer's left. In all versions of the game detailed in this section, this is referred to as the 'Initial Deal'.

- 11.11** The five communal cards detailed in rule 11.8 will be dealt at appropriate stages of the game, as prescribed within the specific game variations detailed in this section.
- 11.12** The player and dealer's final hand is always their best five-card hand created by using one, both or neither of their two hole cards, together with some or all of the five communal cards. Any number of players and/or the dealer may 'Play the Board' if this creates their individual best hand.
- 11.13** All wagers made by opposing players will be against the house, and are wagers that the player's hand will achieve a higher poker ranking than the dealer's hand, in accordance with rule 11.7, and/or that their hand will achieve one of the specific hand rankings prescribed within the specific game variations detailed below.
- 11.14** Players will always be invited by the dealer to make any decisions required by the specific game variation, such as whether to 'bet or check', starting in order from the player to the dealer's left.
- 11.15** Wagers are always settled for each player in turn, starting with the player on the dealer's right.

WSOP Texas Hold 'Em Bonus Poker

- 11.16** The following procedures describe the proprietary variation of Texas Hold 'Em called 'Texas Hold 'Em Bonus Poker'. The current proprietor of the game is Progressive Gaming International Corporation (PGIC) and no variations to the game may be put forward without either their prior agreement, or that of a subsequent proprietor.
- 11.17** The initial wager for each participating player, hereafter referred to as the Ante wager, shall be made before any cards are dealt in the game. The Ante wager shall be placed in the designated betting area marked 'Ante'.
- 11.18** At the same time, an optional additional side wager called Bonus Jackpot may also be wagered in the designated betting area marked 'Bonus', provided the participating player has also placed an Ante wager. The Bonus Jackpot is a wager that a player's two hole cards will achieve one of the specific hand rankings given in rule 11.33, irrespective of the hand dealt to the dealer (other than the optional top pay-out, which is dependent on the dealer hand being Ace-Ace).
- 11.19** If after the Initial Deal, an opposing player who has made an Ante wager wishes to continue with that wager, the player must make a further wager, referred to in these rules as the Flop wager. This shall be an amount of **twice the value** of the Ante wager and will be placed in the designated betting area marked 'Flop'.

- 11.20** An opposing player who has made an Ante wager but who does not wish to make a subsequent Flop wager after the Initial Deal shall surrender the amount staked on the Ante wager to the bank (Fold).
- 11.21** Once all participating players have made their decisions to either place a Flop wager or Fold, the dealer will draw three communal cards and place them face up in the designated area marked for the Flop.
- 11.22** The dealer will then ask each participating player with a Flop wager whether they wish to 'check or bet' before the fourth card (the Turn) is revealed.
- 11.23** If a player elects to bet, they must place a wager equal to the amount of their Ante wager in the designated betting area marked 'Turn'.
- 11.24** If the player elects to check they will remain in the game without placing a Turn wager.
- 11.25** Once all participating players have made their decision to check or bet, the dealer will then deal the next communal card face up and place it in the designated area marked for the Turn card.
- 11.26** The dealer will then invite each participating player with a Flop wager whether they wish to check or bet before the fifth card (the 'River') is revealed.
- 11.27** If a player elects to bet, they must place a wager equal to the amount of the Ante wager in the designated betting area marked 'River'.
- 11.28** If the player elects to check, they will remain in the game without placing a River wager.
- 11.29** Once all participating players have made their decision to check or bet, the dealer will then deal the final communal card face up and place it in the designated area marked for the River card.
- 11.30** Once all five communal cards have been dealt, the dealer will expose their own two hole cards face up and announce their best five card poker hand, in accordance with rule 11.7.
- 11.31** Dealing with each player in turn, the dealer will then expose the player's two hole cards and evaluate their best possible five card poker hand in accordance with rule 11.7.
- 11.32** The dealer will announce the player's hand ranking. If the player has a Bonus Jackpot wager, the dealer will also announce whether the player's two hole cards form a winning hand against the pay table given in rule 11.33.
- 11.33** A player with a Bonus Jackpot wager will win if their **two hole cards** alone form one of the following hands, and will be paid minimum odds as follows:

Player's two-card hand	Minimum odds payable
Ace-Ace at same time as dealer Ace-Ace	1000-1**
Ace-Ace	30-1
Ace-King (suited)	25-1
Ace-Queen or Ace-Jack (suited)	20-1
Ace-King (unsuited)	15-1
Pair of Jacks, Queens or Kings	10-1
Ace-Queen or Ace-Jack (unsuited)	5-1
Pair of 2s, 3s, 4s, 5s, 6s, 7s, 8s, 9s or 10s	3-1

** Available at the discretion of the operator

- 11.34** If the two hole cards held by a participating player with a Bonus Jackpot wager do not form one of the hands listed in rule 11.33, the wager will lose and will be surrendered to the bank.
- 11.35** If the dealer's hand has a **higher** poker ranking than the player's five-card hand, the player's Ante, Flop and, where wagered, Turn and/or River wagers will lose and be surrendered to the bank.
- 11.36** If the player's hand is of exactly **equal** ranking to the dealer's hand, the hand is a stand off and the player's Ante, Flop and, where wagered, Turn and/or River wagers will all be returned to the player.
- 11.37** If the player's hand is of a higher poker ranking than the dealer's hand, the player's Flop and, where wagered, Turn and/or River wagers will win and each will be paid, as a minimum, odds of **even money (1-1)**.
- 11.38** If the player's winning hand against the dealer is a Straight or better their Ante wager will win and also be paid, as a minimum, odds of **even money (1-1)**. However, if the winning hand is a **less than a Straight** the Ante wager will be deemed a stand off and will instead be returned to the player.

Progressive Texas Hold 'Em Bonus Wager

- 11.39** At the licence holder's discretion, a casino may introduce an additional feature into the game, namely a Progressive Jackpot wager, either in addition to, or instead of, the Bonus Jackpot wager. The general rules detailed in rule 2.7 of section 2 will apply.
- 11.40** A Progressive Jackpot wager shall be an optional wager that an opposing player may place at the same time as he places an Ante wager.
- 11.41** A Progressive Jackpot wager may not be placed unless an Ante wager has also been placed at the same time.

- 11.42** A Progressive Jackpot wager shall be placed in a designated slot, spot or dedicated area, set into, or otherwise made available at, each playing position.
- 11.43** A Progressive wager is a wager that the player will receive one of the specific five-card hands given in rule 11.44, using any combination of their two hole cards and the five community cards. If such a hand is dealt, the player will win regardless of whether the hand also beat the dealer. Where such a hand comprises all five community cards, all players with a Progressive wager are entitled to Play the Board, ie use the five community cards as their hand.
- 11.44** If upon the hand being revealed, an opposing player who has placed a Progressive Jackpot wager has a hand containing one of the following rankings, the player's Progressive Jackpot wager shall win, and be paid from the Progressive Jackpot Meter, the following **minimum** amounts:
- a) Royal Flush (**100% of the Progressive Jackpot Meter**)
 - b) Straight Flush (**10% of the Progressive Jackpot Meter**)
 - c) Four of a Kind (**500 times the value of the wager**)
 - d) Full House (**100 times the value of the wager**)
 - e) Flush (**50 times the value of the wager**)
- 11.45** Where one of winning hands given in rule 11.44 comprises all five community cards, all players with a Progressive wager are entitled to Play the Board.
- a) Where the winning hand is a Royal Flush, all winning players will share the jackpot meter equally.
 - b) Where the winning hand is a Straight Flush made up of all five community cards, all winning players will receive an equal share equivalent to 10% of the jackpot total.
 - c) Where the winning hand is a Four of a Kind or below, each player will receive the appropriate fixed payment detailed in points c), d) and e) in rule 11.44.
- 11.46** If one or more participating players is dealt a Royal Flush or Straight Flush using either or both of their hole cards together with a combination of community cards, payment will be made in seating order, starting from the dealer's right.
- 11.47** Progressive wagers will be settled after all five community cards have been dealt. If a player with a Progressive wager therefore elects to Fold, their cards will remain on the table until the Turn and River cards have been dealt and the outcome of the Progressive wager can be determined.

Ultimate Texas Hold 'Em Poker

- 11.48** The following procedures describe the proprietary variation of Texas Hold 'Em called 'Ultimate Texas Hold 'Em Poker'. The proprietor of the game is Shufflemaster Gaming Inc. and no variations to the game may be put forward without their prior agreement.
- 11.49** An opposing player will make **two** initial wagers of equal amount. These wagers are hereafter referred to as the Ante wager and the Blind wager and shall be made before any cards are dealt in the game. The wagers will be placed in the designated betting areas marked 'Ante' and 'Blind'. These are initial wagers that the player's hand will have a higher ranking than the dealer's hand.
- 11.50** An optional additional side wager is called Trips Bonus. This side wager may be of any amount within the table limits, and is wagered in the designated betting area marked 'Trips' at the start of the game before any cards are dealt, provided the player has also placed an Ante and Blind wager. The Trips is a wager that the player's best five-card hand will achieve one of the particular hand ranking given in rule 11.72, irrespective of the hand dealt to the dealer.
- 11.51** Immediately after the Initial Deal, the dealer may deal the five communal cards face down in the area allocated on the table. This is permitted to allow a shuffle machine to deliver five cards followed by a succession of two for each player, regardless of the number of participants. Alternatively, the communal cards can be dealt as and when they are required in the course of the game. When all players have been dealt their hand, the dealer will ask each participating player with an Ante and Blind wager whether they wish to 'check or bet' before the Flop is revealed.
- 11.52** If the player elects to place an additional wager, hereafter called the Play wager, **before** the three communal Flop cards are dealt, they have the option of wagering either **three or four times** the amount of their Ante wager as their Play wager.
- 11.53** Having taken the option to place their Play wager before the Flop, a player may not then wager again during the remainder of the game, and cannot change their wager once the Flop has been dealt.
- 11.54** If the player elects instead to check, they will remain in the game without placing a Play wager before the Flop is dealt.
- 11.55** Once all opposing players have made their decision to check or bet, the dealer will then deal/reveal the three communal Flop cards.
- 11.56** The dealer will then invite each of the opposing players in turn who has not yet placed a Play wager, whether they wish to check or bet before the fourth and fifth cards (the Turn and River) are revealed.

- 11.57** If a player elects to bet, they must place a Play wager of **twice the amount of the Ante** wager in the designated betting area. They may not then wager again during the remainder of the game.
- 11.58** If the player again elects to check they will remain in the game without placing a Play wager before the Turn and River cards are dealt or revealed.
- 11.59** Once all relevant players have made their decision to check or bet, the dealer will then deal or reveal both the two remaining communal cards (the Turn and River).
- 11.60** Starting from the player on their left, the dealer will then invite all remaining opposing players in turn who have not yet placed a Play wager, whether they wish to bet or fold.
- 11.61** If a player elects to bet, they must place a Play wager of **an equal amount of the Ante** wager in the designated betting area.
- 11.62** If the player still does not wish to place a Play wager, they must fold. Their Ante, Blind and, where applicable, Trips Bonus wagers will then lose and the amount staked will be surrendered to the bank. However, if the folded hand contains three of a kind or better and thus qualifies for Trips Bonus wager pay out in accordance with rule 11.72, the Trips Bonus will be paid, irrespective of the hand being folded.
- 11.63** Once all remaining players have made their decision to check or fold, the dealer will expose their two hole cards face up and announce their best five card poker hand in accordance with rule 11.7.

Pay out if dealer has a Qualifying Hand in Ultimate Texas Hold 'Em Poker

- 11.64** The dealer's best hand must contain at least a pair to qualify, hereafter called a Qualifying Hand.
- 11.65** If the dealer **does** have a Qualifying Hand then they will compare it against each player's best five-card hand in turn.
- 11.66** If the dealer's Qualifying Hand is of identical value to the player's hand, the Ante, Play and Blind wagers will be returned to the player.
- 11.67** If the dealer's Qualifying Hand is of a higher ranking than the player's hand, the player's Ante, Play and Blind wagers are lost and surrendered to the house.
- 11.68** If the player's hand is of a higher ranking to the dealer's Qualifying Hand, their Ante and Play wager will be paid, at a minimum, odds of **even money (1-1)**.

11.69 If the player's hand is of a higher ranking than the dealer's hand, but **does not** contain a Straight or better, the Blind wager will be returned to the player.

11.70 If the player's hand is of a higher ranking than the dealer's hand, and **does** contain a Straight or better, their **Blind** wager will win and be paid odds at a minimum to the following pay table:

Player's five-card hand	Minimum odds payable
Royal Flush	500-1
Straight Flush	50-1
Four of a Kind	10-1
Full House	3-1
Flush	3-2
Straight	1-1

11.71 If the player's hand is of a lower ranking than the dealer's hand, their Play and Blind wagers will lose and be surrendered to the bank.

11.72 If a player who has placed the optional **Trips Bonus** has a hand containing Three of a Kind or better, the wager will win and be paid, as a minimum, the following odds:

Player's five-card hand	Minimum odds payable
Royal Flush	50-1
Straight Flush	40-1
Four of a Kind	20-1
Full House	7-1
Flush	6-1
Straight	4-1
Three of a Kind	3-1

Please note that the above table shows the minimum permitted odds that may be paid, drawn from the pay tables given in Section 11.73. However, the full list of minimum odds is not, in itself, a well-balanced pay table and in fact carries a house edge of 9.12%. It is therefore recommended that they are only used as a guide and not as a pay table in themselves.

11.73 In addition to offering, as a minimum, the odds given in rule 11.72 above, odds for the Trips Bonus may be presented as complete pay tables, in accordance with rule 2.9 given in section 2. Permitted pay tables are as follows:

Pay table 1		Pay table 2	
Royal Flush	50-1	Royal Flush	50-1
Straight Flush	40-1	Straight Flush	40-1
Four of a Kind	30-1	Four of a Kind	30-1

Full House	9-1	Full House	8-1
Flush	7-1	Flush	6-1
Straight	4-1	Straight	5-1
Three of a Kind	3-1	Three of a Kind	3-1

Pay table 3

Royal Flush	50-1
Straight Flush	40-1
Four of a Kind	30-1
Full House	8-1
Flush	7-1
Straight	4-1
Three of a Kind	3-1

Pay table 4

Royal Flush	50-1
Straight Flush	40-1
Four of a Kind	20-1
Full House	7-1
Flush	6-1
Straight	5-1
Three of a Kind	3-1

11.74 If a player who has placed the optional Trips Bonus wager does not have a hand containing Three of a Kind or better, the Trips Bonus wager will lose and be surrendered to the House.

Pay out if dealer does not have a Qualifying Hand in Ultimate Texas Hold 'Em Poker

11.75 If the dealer **does not** have a Qualifying Hand in accordance with rule 11.64, then the Ante wager of each player who has not folded will be returned to them.

11.76 The dealer will then deal with the Play, Blind and optional Trips Bonus wagers for each player in turn in exactly the same way as for a Qualifying Hand, in accordance with rules 11.64 to 11.72.

Casino Hold 'Em Poker

11.77 The following procedures describe the proprietary variation of Texas Hold 'Em called 'Casino Hold 'Em Poker'. The proprietor of the game is TCSJohnHuxley, and no variations to the game may be put forward without their prior agreement.

11.78 Each opposing player places an initial wager, hereafter called the Ante wager, in the designated area marked 'Ante'.

11.79 An optional side wager called 'AA Bonus' may also be placed in the designated area marked 'AA', provided the player has also placed an Ante wager at the same time.

11.80 Immediately after the Initial Deal, the dealer will draw the first three communal cards and place them face up in the designated Flop area.

11.81 Any opposing player who has made an Ante wager and wishes to remain in the game shall then make a further wager of **twice the value** of their Ante wager (hereafter called the Call wager). This will place it in the designated area marked 'Call'.

11.82 If an opposing player does not wish to place a Call wager to remain in the game, they must Fold. Their Ante and optional AA Bonus wagers will then lose and be surrendered to the bank.

11.83 When all players have decided whether to Call or Fold, the dealer will then determine whether any player has a winning AA bonus hand, using their two hole cards and the three card flop. Any player who has a Pair of Aces or better will win and be paid minimum odds in accordance with the following pay table:

Hand	Minimum odds
Flush or Higher	25-1
Pair of Aces to Straight	7-1

11.84 If a player with an AA Bonus wager does not have a Pair of Aces or better, the wager will lose and be surrendered to the bank.

11.85 Once all AA Bonus wagers have been settled or surrendered, the dealer will then draw the fourth and fifth communal cards together, and will place them face up in the area designated for the Turn and River cards.

11.86 The dealer will then reveal their own two hole cards and will declare their best five-card hand in accordance with rule 11.7.

11.87 The dealer must have at least a pair of fours to qualify (hereafter called a Qualifying Hand).

11.88 If the dealer **does not** have a Qualifying Hand then the Call wager for each remaining player will be returned. The dealer will determine the best five-card hand of each player in turn and the Ante wager for each player will be paid in accordance with the following minimum odds:

Hand	Minimum odds
Royal Flush	100-1
Straight Flush	20-1
Four of a Kind	10-1
Full House	3-1
Flush	2-1
Straight or less	Even (1-1)

11.89 If the dealer **does** have a Qualifying Hand, in accordance with rule 11.87, then the dealer will determine the best five-card hand for each player in turn.

11.90 If the dealer's Qualifying Hand is of a higher poker ranking than the player's hand, the player's Ante and Call wagers will lose and will be surrendered to the bank.

11.91 If the player's Qualifying Hand is of a higher poker ranking than the dealer's, the player's Call wager will be paid at minimum odds of **even money (1-1)**. Their Ante wager will be paid in accordance with the minimum odds given in rule 11.88.

Progressive wager

11.92 At the licence holder's discretion, a casino may introduce an additional feature into the game, namely a Progressive Jackpot wager called 'Progressive 5/7', either in addition to, or instead of, the 'AA Bonus' wager. The general rules detailed in section 2.7 will apply.

11.93 The Progressive Jackpot wager shall be an optional wager that an opposing player may place at the same time as he places an Ante wager.

11.94 The Progressive Jackpot wager may not be placed unless an Ante wager has also been placed at the same time.

11.95 The Progressive Jackpot wager shall be placed in a designated slot, spot or dedicated area, set into or otherwise made available at each playing position.

11.96 The Progressive wager is a wager that the player will receive one of the specific five-card hands given in rule 11.97 using any combination of their two hole cards and the five community cards. If such a hand is dealt, the player will win regardless of whether the hand also beat the dealer.

11.97 If upon the hand being revealed, an opposing player who has placed a Progressive Jackpot wager has a hand containing one of the following rankings, the player's Progressive Jackpot wager shall win, and be paid from the Progressive Jackpot Meter, the following minimum amounts:

- a) **Royal Flush (100% of the Progressive Jackpot Meter)**
- b) **Straight Flush (10% of the Progressive Jackpot Meter)**
- c) **Four of a Kind (100 times the value of the wager)**
- d) **Full House (10 times the value of the wager)**

11.98 Where one of winning hands given in rule 11.97 comprises all five community cards, all players with a Progressive wager are entitled to Play the Board, ie use the five community cards as their hand:

- a) Where the winning hand is a Royal Flush, all winning players will share the jackpot meter equally.
- b) Where the winning hand is a Straight Flush made up of all five community cards, all winning players will receive an equal share equivalent to 10% of the jackpot total.

c) Where the winning hand is a Four of a Kind or Full House, each player will receive the appropriate fixed payment detailed in points c) and d) in rule 11.97.

11.99 If one or more participating players is dealt a Royal Flush or Straight Flush, using either or both of their hole cards together with a combination of community cards, payment will be made in seating order starting from the dealer's right.

11.100 Progressive wagers will be settled after all five community cards have been dealt. If a player with a Progressive wager therefore elects to Fold, their cards will remain on the table until the Turn and River cards have been dealt and the outcome of the Progressive wager can be determined.

Two Way Texas Hold 'Em Casino Poker

11.101 The following procedures describe the proprietary variation of Texas Hold 'Em called 'Two Way Texas Hold 'Em Casino Poker'. The proprietor of the game is Prime Table Games, and no variations to the game may be put forward without their prior agreement.

11.102 The player shall place **three** initial wagers of equal amounts, hereafter called the Ante wager, the Blind wager and the Two Way wager before the Initial Deal. All subsequent optional wagers are placed **after** the cards are drawn.

11.103 The dealer will make the Initial Deal, and will then immediately draw the first three communal cards, which they will place face up in the area designated for the Flop.

11.104 All opposing players then have the opportunity to place an **optional** additional wager of equal amount to their Ante wager (hereafter called the Flop wager), which they will place in the designated betting area.

11.105 When all opposing players have made their decision whether or not to place a Flop wager, the dealer will draw the last two communal cards, and will place them face up in the area designated for the Turn and River cards.

11.106 All opposing players then have the opportunity to place an **optional** additional wager (hereafter called the River wager) which they will place in the designated betting area.

11.107 When all opposing players have made their decision whether or not to place a River wager, the dealer will reveal their own two hole cards, and will determine their best five-card hand.

11.108 The dealer must have at least a pair for their hand to qualify (hereafter called a Qualifying Hand).

- 11.109** If the dealer's hand does **not** qualify, the Blind wager and any optional Flop or River wagers for each opposing player will be returned. However, the **Ante wager remains 'in action'** and will be contested against the dealer's hand. The dealer will determine the best five-card hand of each player in turn.
- 11.110** If the dealer's hand does not qualify, and is of a **lower** ranking than the player's hand, the Ante wager will win and be paid minimum odds of **even money (1-1)**.
- 11.111** If the dealer's hand does not qualify, but is of a **higher** ranking than the player's hand, the Ante wager will lose and be surrendered to the bank.
- 11.112** If the dealer **does** qualify, they will determine the best five-card hand of each player in turn.
- 11.113** If the dealer's hand qualifies and has a **lower** ranking than the player's hand, the player's Ante, Blind and any Flop or River wagers will **all** be paid minimum odds of **even money (1-1)**.
- 11.114** If the dealer's hand qualifies and has a **higher** ranking than the player's hand, the player's Ante, Blind and any Flop or River wagers will all lose and be surrendered to the house.
- 11.115** The Two Way wager is unaffected by whether or not the dealer has a hand in Action. If neither the dealer's or the player's hand contains a **Straight or better**, the player's Two Way wager will lose and be surrendered to the House.
- 11.116** If either the player and/or the dealer has a Straight or better, the player's Two Way wager will be paid the minimum odds given in rule 11.117 for **whichever** of the player or dealer hands has the higher ranking.

For example, if the player has a Four of a Kind and the dealer only has a Full House, the player will be paid odds for Four of a Kind, as they have the higher ranking hand. However, if the player only has a Full House and the dealer has a higher ranking Four of a Kind, the player will be paid the higher odds for the dealer's Four of a Kind in settlement of their Two Way wager.

- 11.117** The table of minimum odds for settlement of Two Way wagers is as follows:

Hand	Minimum odds
Straight Flush	50-1
Four of a Kind	25-1
Full House	4-1
Flush	3-1
Straight	2-1

12. Let it Ride

The table layouts

- 12.1 Figure 23 shows an example of the style of game layout that may be offered to players. The proprietor of the game is Shufflemaster Inc and no variations to the game may be put forward without their prior agreement.

Figure 23

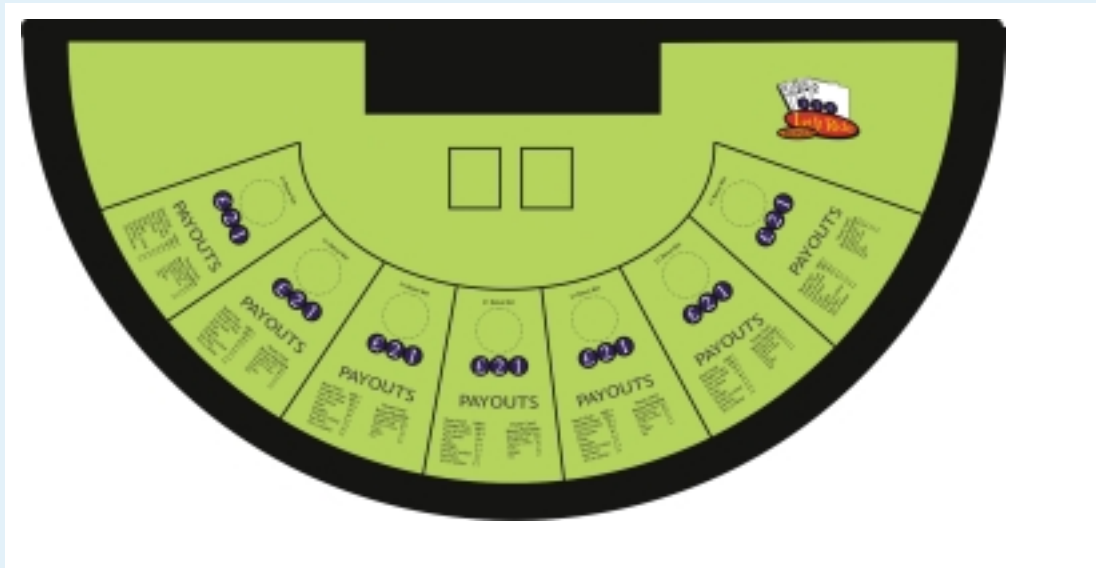

General rules

- 12.2 Only the variations and side wagers listed in this section are permitted, unless agreed by the Proprietors and then approved by the Commission in accordance with the rules detailed in section 2.3 and 2.4.
- 12.3 The game shall be played with a single pack of 52 cards.
- 12.4 Operators must have procedures in place to ensure the security and integrity of the cards.
- 12.5 The maximum and minimum wagers permitted shall be shown on a notice prominently displayed at the table. Partnerships with a view to exceeding the maximum stake shall not be permitted.
- 12.6 The relative value of each of the cards is as follows (in descending order): Ace, King, Queen, Jack, 10, 9, 8, 7, 6, 5, 4, 3, and 2, except that the Ace may be used as a value of one, as detailed in 12.7 below, (being 3, 2, Ace).

12.7 The terms used to describe the five-card hands, and descending order of hand rankings, shall be in accordance with the following:

- a) **Royal Flush** – Ace, King, Queen, Jack and 10 of the same suit;
- b) **Straight Flush** – five cards of consecutive values of the same suit;
- c) **Four of a Kind** – four cards of the same value;
- d) **Full House** – three cards of the same value together with two cards of the same value being different to the first value;
- e) **Flush** – five cards of the same suit;
- f) **Straight** – five cards of consecutive values not being a Royal Flush or a Straight Flush;
- g) **Three of a Kind** – three cards of the same value;
- h) **Two pairs** – two cards of the same value together with two cards of the same value being different to the first value;
- i) **One pair** – two cards of the same value;
- j) **High Card/No pair** – the highest value cards of the hand.

The minimum winning hand in the game of Let it Ride is a pair of tens or better.

12.8 Only one wager may be accepted on each playing position and no individual player may place a wager on more than one playing position.

12.9 All wagers made by opposing players will be against the house. Players will wager that their hand achieves a particular hand ranking prescribed within the pay tables given in rule 12.27, when the three cards dealt to their hand are combined with the two community cards dealt to the dealer.

12.10 An additional optional side wager may be placed by participating players, which will be a wager that the three cards dealt to a player's hand will achieve a particular three-card hand ranking within the pay tables given in rule 12.30 and 12.31.

12.11 Cards will be dealt starting from the player to the dealer's left.

12.12 All settlement of bets and decisions as to whether a player wishes to Let it Ride will be made by each player in turn, starting from the player to the dealer's right.

Initial wager

12.13 Prior to any cards being dealt, all participating players must make three equal wagers (hereafter called the Mandatory Wagers) and place them in the betting positions marked '1', '2' and '£' on the playing position in front of them. The '£' wager is the minimum amount that the player must risk, whilst the first and second wagers ('1' and '2') may be pulled back during the course of the game, in accordance with the rules of this section.

- 12.14** Participating players who have placed the three Mandatory Wagers may also place an optional side wager (hereafter called the Three Card Bonus) of an amount no more or less than the minimum and maximum wager applicable to that table. The Three Card Bonus wager does not have to be of equal value to the Mandatory Wagers.
- 12.15** After all Mandatory Wagers and optional Three Card Bonus wagers have been placed, the dealer will deal three cards face down to each player, starting from the player to their left, and three cards to themselves. The dealer's cards are **not** considered as a separate hand.
- 12.16** The dealer's top **two** cards (hereafter called the 'community cards') will be placed face down in the area designated for the community cards. If a shuffle machine is used and dispatches three cards to the dealer, their third card (top) will be burned and placed in the discard.
- 12.17** Each player will decide whether their three card hand has the potential to achieve a minimum ranking of a pair of tens or better, when combined with the two (as yet unknown) community cards.
- 12.18** Each player will be invited to decide whether they wish to withdraw their first ('1') Mandatory Wager or Let it Ride, that is, remain in play.
- 12.19** If a player elects to withdraw their first wager, the dealer will return the wager to the player.
- 12.20** If the player elects to 'Let it Ride', it will be left in position '1' and will remain in play.
- 12.21** When all players have made their decision to either withdraw their first wager or Let it Ride, the dealer will reveal their first community card in front of them, being the card to their left.
- 12.22** Each player will then be invited to decide in turn whether to withdraw their second ('2') wager or Let it Ride.
- 12.23** If a player elects to withdraw their second wager, the dealer will return the wager to the player.
- 12.24** If the player elects to Let it Ride, it will be left in position '2' and will remain in play.
- 12.25** When all players have made their decision to either withdraw their second wager or Let it Ride, the dealer will reveal their second community card in front of them, being the card to their right.
- 12.26** Starting from the player to their right, the dealer will then determine whether each player has a winning five-card hand in accordance with rule 12.7, using all three of the player's cards combined with both the two community cards.

12.27 The Player will win if they have one of the hand rankings below:-

Hand	Paid Minimum Odds
Royal Flush	100 - 1
Straight Flush	50 - 1
Four of a Kind	25 - 1
Full House	11 - 1
Flush	8 - 1
Straight	5 - 1
Three of a Kind	3 - 1
Two Pairs	2 - 1
Pair of Tens, Jacks, Queens, Kings or Aces	Evens

NB the above table shows the minimum permitted odds that may be paid, drawn from the Pay Tables given below. However, the full list of minimum odds is not, in itself, a well balance Pay Table and in fact carries a House Edge of 5.25%. It is therefore recommended that they only be used as a guide and not as a Pay Table in themselves.

In addition to offering, as a minimum, the odds given above, above, odds for the the standard wagers on Let it Ride may be presented as complete pay tables, in accordance with Rule 2.9 given in section 2of this document. Permitted pay tables are as follows:-

Pay table 1

Hand	Paid Minimum Odds
Royal Flush	100 - 1
Straight Flush	50 - 1
Four of a Kind	30 - 1
Full House	15 - 1
Flush	9 - 1
Straight	6 - 1
Three of a Kind	3 - 1
Two Pairs	2 - 1
Pair of Tens, Jacks, Queens, Kings or Aces	Evens

Pay table 2

Hand	Paid Minimum Odds
Royal Flush	200 - 1
Straight Flush	100 -1
Four of a Kind	40 -1
Full House	15 -1
Flush	9 - 1
Straight	6 - 1
Three of a Kind	3 - 1
Two Pairs	2 - 1
Pair of Tens, Jacks, Queens, Kings or Aces	Evens

Pay table 3

Hand	Paid Minimum Odds
Royal Flush	500 - 1
Straight Flush	100 -1
Four of a Kind	25 -1
Full House	15 -1
Flush	10 - 1
Straight	5 - 1
Three of a Kind	3 - 1
Two Pairs	2 - 1
Pair of Tens, Jacks, Queens, Kings or Aces	Evens

Pay table 4

Hand	Paid Minimum Odds
Royal Flush	1000 - 1*
Straight Flush	200 -1
Four of a Kind	50 -1
Full House	11 -1
Flush	8 - 1
Straight	5 - 1
Three of a Kind	3 - 1
Two Pairs	2 - 1
Pair of Tens, Jacks, Queens, Kings or Aces	Evens

***It is permissible to apply a maximum ceiling to the total sterling amount that will be paid at a table to an individual who wins with a Royal Flush, provided:**

- a) It applies only to the 1000-1 Royal Flush payout;
- b) There is very clear signage at the table highlighting the maximum total amount that will be paid to that player for the standard wagers, regardless of the value of the bets placed or how many of the three standard wagers remain in play at the end of the game;
- c) That all players who have placed wagers that would be impacted by the maximum payout are informed of this fact before the game commences, so that they are in absolutely no doubt of the fact and have the opportunity to remove or adjust their wager before the game takes place if they wish.

12.28 If the player does not have a hand containing, as a minimum, a Pair of Tens or better, their hand will lose and however many of their three Mandatory Wagers are still in play will be surrendered to the bank.

12.29 If the player does have a hand containing, as a minimum, a Pair of Tens or better, then however many of their three Mandatory Wagers are left in play will **each** be paid the relevant minimum odds given in rule 12.27.

12.30 For Players who placed the optional Three Card Bonus wager at the beginning of the game, the Dealer will also determine whether the Player's own three card hand has achieved one of the following hand rankings:-

Hand	Paid Minimum Odds
Mini Royal Flush (Suited Q,K,A)	50-1
Straight Flush	40-1
Three of a Kind	8-1
Straight	4-1
Flush	3-1
Pair	1-1

NB the above table shows the minimum permitted odds that may be paid, drawn from the Pay Tables given in Section 12.31. However, the full list of minimum odds is not, in itself, a well balance Pay Table and in fact carries a House Edge of 18.7%. It is therefore recommended that they only be used as a guide and not as a Pay Table in themselves.

12.31 In addition to offering, as a minimum, the odds given in rule 12.30, above, odds may be presented as complete pay tables, in accordance with rule 2.9 given in section 2. Permitted pay tables are as follows:

Pay table 1

Hand	Paid minimum odds
Mini Royal Flush (Suited Queen, King, Ace)	50-1
Straight Flush	40-1
Three of a Kind	30-1
Straight	6-1
Flush	4-1
Pair	1-1

Pay table 2

Hand	Paid minimum odds
Mini Royal Flush (Suited Queen, King, Ace)	50-1
Straight Flush	40-1
Three of a Kind	30-1
Straight	5-1
Flush	4-1
Pair	1-1

Pay table 3

Hand	Paid minimum odds
Mini Royal Flush (Suited Queen, King, Ace)	50-1
Straight Flush	40-1
Three of a Kind	30-1
Straight	6-1
Flush	3-1
Pair	1-1

12.32 If the three cards dealt to the hand of a player with a Three Card Bonus wager do not contain at least a pair, their Three Card Bonus will lose and be surrendered to the house.

12.33 If the three cards dealt to the hand of a player with a Three Card Bonus wager do contain at least a pair, their Three Card Bonus wager will win and be paid the minimum odds given in rule 12.30.

13. Pai Gow Poker

The table layout

Figure 24 shows an example of the style of games layout that may be offered to players. It illustrates the range of wages available.

Figure 24:



General rules

- 13.1 Only the variations and side wagers listed in this section are permitted, unless agreed by the proprietors and then approved by the Commission in accordance with the rules detailed in section 2.3 and 2.4.
- 13.2 The game shall be played with a single pack of 53 cards **including the joker**.
- 13.3 Operators must have procedures in place to ensure the security and integrity of the cards.
- 13.4 The maximum and minimum wagers permitted shall be shown on a notice prominently displayed at the table. Partnerships with a view to exceeding the maximum stake shall not be permitted.
- 13.5 The relative value of each of the cards is as follows (in descending order): Ace, King, Queen, Jack, 10, 9, 8, 7, 6, 5, 4, 3, and 2, except that the Ace may be used as a value of one, as detailed in 12.7 below (being 3, 2, Ace). The Joker is valued in accordance with rule 13.9.
- 13.6 The player must set their best five-card hand **and** two-card hand from the seven cards they are dealt, in accordance with rule 13.19.

- 13.7** The terms used to describe the **five-card hands**, and descending order of hand rankings, shall be in accordance with the following:
- a) **Five Aces** – Four Aces and the Joker;
 - b) **Royal Flush** – Ace, King, Queen, Jack and ten of the same suit;
 - c) **Straight Flush** – five cards of consecutive values of the same suit. Please note, the second highest straight flush (to 10, Jack, Queen, King, Ace as the highest) is Ace, 2, 3, 4, 5 in Pai Gow Poker;
 - d) **Four of a Kind** – four cards of the same value;
 - e) **Full House** – three cards of the same value together with two cards of the same value being different to the first value;
 - f) **Flush** – five cards of the same suit;
 - g) **Straight** – five cards of consecutive values not being a Royal Flush or a Straight Flush. Please note, the second highest straight (to 10, Jack, Queen, King, Ace as the highest) is Ace, 2, 3, 4, 5 in Pai Gow Poker.
 - h) **Three of a Kind** – three cards of the same value;
 - i) **Two pairs** – two cards of the same value together with two cards of the same value being different to the first value;
 - j) **One pair** – two cards of the same value;
 - k) **High Card/No pair** – the highest value cards of the hand.
- 13.8** The **two-card hand** will be either a pair or two individual cards. The highest two-card hand is a pair of Aces, and the lowest is 2-3. A Straight or a Flush do not apply within the ranking of the two-card hand.
- 13.9** **The Joker** can be used to complete a Straight, a Flush or a Straight Flush but is otherwise **treated as an Ace**.
- 13.10** Only one wager may be accepted on each playing position and no individual player may place a wager on more than one playing position.
- 13.11** All wagers made by opposing players will be against the house. Players will wager that **both** their five-card hand **and** their two-card hand achieve higher rankings than the equivalent hands dealt and arranged by the dealer.
- 13.12** Optional side wagers may be made available in the game, as described in rules 13.28 onwards. Only one form of optional side wager may be offered on any particular table.
- 13.13** Cards will be dealt starting from the player to the dealer's left.
- 13.14** All settlement of wagers will be made to each player in turn, starting from the player to the dealer's right.

Initial wager

- 13.15** Prior to any cards being dealt, all participating players must place a wager (Standard Wager).
- 13.16** At the same time, players may place an optional side wager as described in rule 13.28 onwards, provided they have also placed a Standard Wager.
- 13.17** Each participating player and the dealer will be dealt seven cards in turn, face down.
- 13.18** Each player will then set a five-card hand ('High') and a two-card hand ('Low') from the seven cards they are dealt. The five-card High Hand will be placed in the playing position marked 'H', which is also known as the 'Back'. The two-card Low hand will be placed in the playing position marked 'L', which is also known as the 'Front'.
- 13.19** When setting their hands, the player must make their best five-card hand as the High hand. **The player's two-card hand may not be higher than their five-card hand.** For example, if the player is dealt King, King, 2, 4, 6, 8, 10 of mixed suits and can therefore only make one pair from all the seven cards dealt, that pair must be set within the five-card hand. The pair cannot be set as the two-card hand, as it would then be better than the hand of five unrelated cards.

If the player sets their hands with the two-card hand higher than the five-card hand, then a 'foul' is declared. At the licence holder's discretion the following two options may apply:

- a) Both player hands will automatically lose, regardless of their ranking against the dealer's hand; or
- b) The dealer may re-set the player's hands using the House Way detailed in rule 13.21 and allow them to then remain in play.

Whichever option is being applied, a sign or notice must be displayed at the table to inform players.

- 13.20** Other than abiding by rule 13.19, the player may set their two and five-card hands in whichever way they wish. However, the dealer must always set both their hands in accordance with the House rules ('the House Way') as detailed in rule 13.21.
- 13.21** When all opposing players have set their hands and placed them in the appropriate playing position, the dealer will reveal their own seven cards and set out their best five-card High hand, and their two-card Low hand, face up in the designated area. The dealer must set their hands in accordance with the House Way, as detailed below:

Seven Cards containing:	Place in five-card hand ('Back')	Place in two-card hand ('Front')
High Card/No Pair	Highest Card	2nd and 3rd highest cards
One Pair	Pair	Next two highest singleton cards
Two Pairs criteria given below using following groups: 2s - 6s = Low Pair 7s - 10s = Medium Pair Js - Ks = High Pair	(See below)	
Low Pair + Low Pair or Low Pair + Medium Pair	Split unless holding a King or better, in which case both pairs at the back and next highest two cards at the front	
Low Pair + High Pair or Medium Pair + Medium Pair	Split unless holding an Ace in which case both pairs at the back and next highest two cards at the front	
Medium Pair + High Pair or High Pair + High Pair or Pair of Aces + Any other pair	Always Split	
Three Pairs	2nd and 3rd highest pairs	Highest pair
Three of a Kind (other than Aces)	Three of a Kind	Next two highest cards
Three of a Kind Aces	Pair of Aces	Ace + one other card
Three of a Kind twice	Lowest three of a kind	Highest pair
Straights, Flushes, Straight Flushes and Royal Flushes	(See below)	(See below)
- with no pair	When choosing whether to play a Straight, Flush or Straight Flush, play the category that will allow the highest two cards in front	
- with 6th or 7th card included	Play the lower Straight or Flush in the back to place highest cards in front	
- with one pair	Play pair in the front only if a Straight, Flush or Straight Flush can be played in the back	
- with two pair	Use the two pair rules detailed above	
- with three pairs	Use the three pair rules detailed above	

- with Three of a Kind	Play Pair in front
- with Full House	Use Full House rules detailed below
Full House	Always split unless includes a pair of two's and there is an Ace and a King to play in front
- with three of a kind and two pairs or with three of a kind twice	Play highest pair in front
- when 2s, 3s, 4s, 5s or 6s	Keep together and play Four of a Kind in back
- when 7s, 8s, 9s or 10s	Split unless a King or better can be played in front
- when Js, Qs or Ks	Split unless an Ace can be played in front
- when four Aces	Always split
- Four of a Kind with a pair	Play Pair in front
Five Aces	Aces and play three Aces in back and two Aces in front, unless hand includes a pair of Kings, when all five Aces played in back and pair of Kings in front

13.22 The dealer will then compare their own two hands against each opposing player's hands in turn. The player's five-card High hand will be compared against the dealer's **High** Hand first, followed by the two-card (Low) Hand, which is compared to the dealer's **Low** Hand. The dealer will assess the ranking of hands in accordance with rule 13.7. **Both** player hands must beat the dealer for the player's Standard Wager to win.

13.23 If the player's High Hand beats the dealer's equivalent High hand, but their Low hand does not beat the dealer's Low hand, (ie one wins and one loses) the player's Standard wager is a stand off and is returned to the player.

13.24 If both the player's High Hand **and** their Low Hand lose to the dealer, their Standard wager is lost and will be surrendered to the bank.

13.25 If there is an **exact** match between the player's High Hand and the dealer's High Hand, the dealer will win the High Hand. Similarly, if there is an **exact** match between the player's Low Hand and the dealer's Low Hand, the dealer will win the Low Hand.

13.26 If the player's High Hand beats the dealer's High Hand, and their Low Hand beats the dealer's Low hand (ie both hands win) the player's standard wager will win and be paid minimum odds of **even money less a 5% commission**.

13.27 The dealer will then settle the player's optional side wager, in accordance with rules 13.28 and onwards.

Permitted variations to Pai Gow Poker

'FORTUNE PAI GOW POKER' side wager

- 13.28** It is at the discretion of the licence holder whether or not to offer the 'Fortune Pai Gow' side wager as an additional, optional wager in the standard game of Pai Gow Poker. The proprietor of the side wager is Shufflemaster Inc and no variations may be put forward without their prior agreement.
- 13.29** The feature shall only be available at a table or tables marked for the provision of the wager, hereafter called the 'Fortune side wager'.
- 13.30** The Fortune side wager is an optional bonus wager that considers the player's best possible hand from all seven cards dealt to them, and is reconciled against an approved pay table (see rule 13.36).
- 13.31** Players may wager any amount within the table limits as their Fortune side wager, which must be wagered at the same time as the Standard wager, but need not be of equal value to it.
- 13.32** Players who place a Fortune side wager that is equal to, or exceeds, the amount prescribed under the house rules, will qualify for a potential 'Envy Bonus' as detailed in rule 13.38 onwards. Such a hand is hereafter referred to as an 'Envy Qualifying Hand'. The qualifying amount for an Envy Bonus must be clearly displayed at the table.
- 13.33** The dealer will place an Envy Bonus marker alongside all Fortune side wagers that relate to Envy Qualifying Hands.
- 13.34** Any Fortune side wagers will be settled at the same time as the Standard Pai Gow wager for each player.
- 13.35** If the player's hand **does not** achieve one of the hand rankings given in rule 13.36, it will not qualify for a Fortune Pai Gow pay out. Their Fortune side wager will lose and be surrendered to the house.
- 13.36** If the player's hand **does** achieve one of the following hand rankings, it will qualify for a Fortune Pai Gow pay out. The Fortune side wager will be settled and paid, as a minimum, the odds listed below:

Hand	Minimum odds payable
7 Card Straight Flush	2500-1
Royal Flush + King/Queen of a same suit	1000-1
7 Card Straight Flush with Joker	500-1
5 Aces (All four plus Joker)	250-1
5 card Royal Flush	100-1
5 card Straight Flush	50-1
Four of a Kind	20-1

Full House	5-1
5 card Flush	4-1
Three of a Kind	3-1
Five card Straight	2-1
Three Pair	Push/standoff**

**Available at discretion of operator

Please note that the above table shows the minimum permitted odds that may be paid, drawn from the pay tables given in Section 13.37. However, the full list of minimum odds is not, in itself, a well-balanced Pay Table. It is therefore recommended that they are only used as a guide and not as a pay table in themselves.

13.37 In addition to offering, as a minimum, the odds given in rule 13.36 above, odds may be presented as complete pay tables, in accordance with rule 2.9 given in section 2 of this document. Permitted pay tables are as follows:

Pay table 1

7 Card Straight Flush	5000-1
Royal Flush + King/Queen of a same suit	1000-1
7 Card Straight Flush with Joker	750-1
5 Aces (All four plus Joker)	250-1
5 card Royal Flush	100-1
5 card Straight Flush	50-1
Four of a Kind	20-1
Full House	5-1
5 card Flush	4-1
Three of a Kind	3-1
Five card Straight	2-1
Three Pair	Push/standoff

Pay table 2

7 Card Straight Flush	8000-1
Royal Flush + King/Queen of a same suit	2000-1
7 Card Straight Flush with Joker	1000-1
5 Aces (All four plus Joker)	400-1
5 card Royal Flush	150-1
5 card Straight Flush	50-1
Four of a Kind	25-1
Full House	5-1

5 card Flush	4-1
Three of a Kind	3-1
Five card Straight	2-1

Envy Bonus

- 13.38** If any player on the table has an Envy Bonus marker alongside their wager, in accordance with rule 13.33, all cards will be left in place until the dealer has settled the wagers for all opposing players. They will then assess whether one or more Envy Bonuses are payable to Envy Qualifying Hands.
- 13.39** If the player's hand qualifies for a Fortune Pai Gow pay out, and has a marker or other indicator to show that it qualifies for a potential Envy Bonus, in accordance with rule 13.33, the marker will be left in place after the dealer has settled all wagers for that player and remain there whilst they settle wagers for all remaining players.
- 13.40** After all hands and Standard wagers and Fortune side wagers for opposing players have been settled, the dealer will determine whether any player at the table has a seven-card hand that contains Four of a Kind or better.
- 13.41** A player cannot earn an Envy Bonus on his own hand, or for the dealer's hand.
- 13.42** If no player has a seven-card hand containing Four of a Kind or better, then no Envy Bonus is payable. The dealer will therefore collect the cards and Envy Bonus markers and the game will be over.
- 13.43** If one player has a seven-card hand containing Four of a Kind or better, then an Envy Bonus is payable to each player who has an Envy Qualifying Hand.
- 13.44** If more than one player has a seven-card hand containing Four of a Kind or better, then a separate Envy Bonus is payable for **each** of those winning hands to all Envy Qualifying hands.
- 13.45** Winning Envy bonuses on qualifying hands will be paid, as a minimum, the following amounts:

Seven card hand	Minimum amounts paid for Envy Bonus
7 Card Straight Flush	£500
Royal Flush + Royal Match	£125
7 card Straight Flush with Joker	£50
5 Aces (all four plus Joker)	£25
5 Card Royal Flush	£10
Straight Flush	£5
Four of a Kind	£2

In addition to offering, as a minimum, the odds given above, amounts may be presented for Envy Bonuses as complete pay tables, in accordance with rule 2.9 given in section 2 of this document. Examples permitted include:

Pay table 1

Minimum odds given above

Pay table 2

Seven card hand	Minimum amounts paid for Envy Bonus
7 Card Straight Flush	£2500
Royal Flush + Royal Match	£500
7 card Straight Flush with Joker	£250
5 Aces (all four plus Joker)	£100
5 Card Royal Flush	£25
Straight Flush	£10
Four of a Kind	£2

JOKOLOR side wager

- 13.46** It is at the discretion of the licence holder whether or not to offer the 'Jokolor' side wager as an additional, optional wager in the standard game of Pai Gow Poker. The proprietor of the side wager is Prime Table Games and no variations may be put forward without their prior agreement.
- 13.47** The feature shall only be available at a table or tables marked for the provision of the wager, hereafter called the Jokolor side wager.
- 13.48** The Jokolor side wager is an optional bonus wager payable if the player's seven-card hand includes the Joker, if all seven cards are of the same colour, or where the hand consists of six cards of the same colour plus the Joker.
- 13.49** Players may wager any amount within the table limits as their Jokolor side wager, which must be placed at the same time as the Standard wager, but need not be of equal value.
- 13.50** Any Jokolor side wagers will be settled at the same time as the dealer reconciles the standard Pai Gow wager for each player.
- 13.51** If the player with a Jokolor side wager has one of the hands listed below, it will win and be paid, as a minimum, the following odds:

Seven-card hand	Minimum odds payable for Jokolor
Includes Joker	5-1
All seven cards of same colour	10-1
Six cards of same colour plus Joker	30-1

13.52 If the player's hand **does not** contain one of the hands listed in rule 13.51, their Jokolor side wager will lose and be surrendered to the house.

The Gambling Commission regulates gambling in the public interest. It does so by keeping crime out of gambling, by ensuring that gambling is conducted fairly and openly, and by protecting children and vulnerable people from being harmed or exploited by gambling. The Commission also provides independent advice to government on gambling in Britain.

For further information or to register your interest in the Commission please visit our website at:

www.gamblingcommission.gov.uk

Gambling Commission
Victoria Square House
Victoria Square
Birmingham B2 4BP

T 0121 230 6500

F 0121 230 6720

E info@gamblingcommission.gov.uk